

# ***XA11*** ***XA15***

---

HD Camcorder

**COPYRIGHT WARNING:**

Unauthorized recording of copyrighted materials may infringe on the rights of copyright owners and be contrary to copyright laws.

**Trademark Acknowledgements**

- SD, SDHC and SDXC Logos are trademarks of SD-3C, LLC.
- Microsoft and Windows are trademarks or registered trademarks of Microsoft Corporation in the United States and/or other countries.
- macOS is a trademark of Apple Inc., registered in the U.S. and other countries.
- HDMI, the HDMI logo and High-Definition Multimedia Interface are trademarks or registered trademarks of HDMI Licensing Administrator, Inc. in the United States and other countries.
- "AVCHD", "AVCHD Progressive" and the "AVCHD Progressive" logo are trademarks of Panasonic Corporation and Sony Corporation.
- Manufactured under license from Dolby Laboratories.  
"Dolby" and the double-D symbol are trademarks of Dolby Laboratories.
- Other names and products not mentioned above may be trademarks or registered trademarks of their respective companies.
- This device incorporates exFAT technology licensed from Microsoft.
- "Full HD 1080" refers to Canon camcorders compliant with high-definition video composed of 1,080 vertical pixels (scanning lines).
- This product is licensed under AT&T patents for the MPEG-4 standard and may be used for encoding MPEG-4 compliant video and/or decoding MPEG-4 compliant video that was encoded only (1) for a personal and non-commercial purpose or (2) by a video provider licensed under the AT&T patents to provide MPEG-4 compliant video. No license is granted or implied for any other use for MPEG-4 standard.
- THIS PRODUCT IS LICENSED UNDER THE AVC PATENT PORTFOLIO LICENSE FOR THE PERSONAL USE OF A CONSUMER OR OTHER USES IN WHICH IT DOES NOT RECEIVE REMUNERATION TO (i) ENCODE VIDEO IN COMPLIANCE WITH THE AVC STANDARD ("AVC VIDEO") AND/OR (ii) DECODE AVC VIDEO THAT WAS ENCODED BY A CONSUMER ENGAGED IN A PERSONAL ACTIVITY AND/OR WAS OBTAINED FROM A VIDEO PROVIDER LICENSED TO PROVIDE AVC VIDEO. NO LICENSE IS GRANTED OR SHALL BE IMPLIED FOR ANY OTHER USE. ADDITIONAL INFORMATION MAY BE OBTAINED FROM MPEG LA, L.L.C. SEE [HTTP://WWW.MPEGLA.COM](http://www.mpegla.com)



# Highlights of the Camcorder

The Canon XA15 / XA11 HD Camcorder is a high-performance camcorder whose compact size makes it ideal in a variety of situations. The following are just some of the many functions featured in the camcorder.

## HD Recording

### HD CMOS PRO sensor and DIGIC DV 4 image processor

The camcorder is equipped with a 1/2.84-inch CMOS sensor that captures video at an effective pixel count of approximately 2.91 megapixels (2136x1362). The video is then processed by the DIGIC DV 4 image processor. This allows the camcorder to excel in low-light situations and achieve improved image stabilization.

### Wide zoom lens

With a focal length at full wide angle of 26.8 mm\* (35 mm equivalent), the camcorder has superb wide-angle shooting capability. The lens is also capable of 20x optical zoom.

\* 28.8 mm when using Dynamic IS.

### Shooting video with the look you want

You can adjust many aspects of the picture, such as the color depth, sharpness and brightness so that you create a desired "look" (☐ 67). The camera also comes with preset looks from which you can choose. The first is the [Wide DR] look, which applies a gamma curve with a very wide dynamic range and an appropriate color matrix. The second is the [Highlight Priority] look, which creates a natural gradation in tones and reduces overexposure in bright areas by not compressing highlights. When playing back video shot with that look, you can appreciate the improved detail when using an external monitor set to brighter settings.

## Operability

### Emphasis on versatility

This camcorder has features to make it usable as a main camera but is also small enough to be very portable. The advanced image stabilization (☐ 56) will let you shoot in a variety of situations in the field. The handle unit is removable so you can detach it when you need improved portability and then reattach it when you need extra audio functionality.

### Manual controls at your fingertips

The focus/zoom ring helps you achieve the focus you are looking for. You can also easily change the ring's functionality so that you can operate the zoom. Furthermore, you can assign certain frequently used functions to a customizable button and adjust those functions with the accompanying dial (☐ 90). If those were not enough, the camcorder also features 5 assignable buttons to which you can assign a variety of functions so that you can access them with ease (☐ 91).

### Face detection

When a subject's face is detected, the camcorder can track and focus on it (☐ 50). Furthermore, you can have the camcorder in manual focus but switch to autofocus only when a face is detected, ensuring that important subjects are in focus.

### Infrared recording

Record in darkness using infrared recording (☐ 87). With the built-in infrared light on the handle unit, you can record nocturnal animals in their natural environment or other such scenes.

## AVCHD/MP4 recording and dual recording

When you record, you can choose between AVCHD and MP4 formats (□ 33). You can also use dual recording (□ 41) to record the same scene to both memory cards and even record on both memory cards using different formats. Dual recording is convenient, for example, to create a backup of your recording.

### Special recording modes (□ 43, 85)

When you make recordings, you can change the recording frame rate to achieve a fast or slow motion effect. Alternatively, you can use pre-recording to record 3 seconds before you decide to start recording, helping you capture those hard-to-catch opportunities.

## Other Features

### Versatile audio connectivity

You can use the built-in microphone, MIC terminal or the two INPUT terminals when recording. When using the INPUT terminals, you can even use microphones that require phantom power.

### Audio scene select

With the audio scene select function (□ 76), you can optimize the audio settings of the built-in microphone by selecting the audio scene that matches your surroundings. Your audience will feel even more immersed in the scene during playback.

## LCD screen and viewfinder

The LCD screen and viewfinder both have 100% frame coverage, which will ensure that you can accurately check that your shots are framed how you want them. The LCD screen has incredible clarity, which is indispensable in checking the details of those important shots. The viewfinder can be tilted 45 degrees upward, which gives you additional range and versatility while you shoot.

### Touch AE

By simply touching the screen, you can make dark areas in the picture appear brighter (□ 61). This operation is simple yet allows you to shoot with the desired exposure.

### Additional functions

Other functions include relay recording (□ 41), which allows you to continue recording on the other memory card when one becomes full, and converting scenes to MP4 (□ 114).

# Table of contents

## 1 Introduction 8

- About this Manual 8
  - Conventions Used in this Manual 8
- Supplied Accessories 10
- Names of Parts 11

## 2 Preparations 16

- Attaching the Ferrite Core 16
- Charging the Battery Pack 16
- Preparing the Camcorder 19
  - Attaching the Microphone Holder Unit 19
  - Attaching the Handle Unit 19
  - Using the Lens Hood and Lens Cap 20
  - Using the Viewfinder 20
  - Adjusting the LCD Screen 21
  - Grip Belt and Straps 22

- Basic Operation of the Camcorder 24
  - Turning the Camcorder On and Off 24
  - Setting the Camera Mode 25
  - Using the Touch Screen 25
  - Using the FUNC. Button and Joystick 26

- First Time Settings 27
  - Setting the Date and Time 27
  - Changing the Language 28
  - Changing the Time Zone 28
  - Using the Menus 29

- Using a Memory Card 31
  - Memory Cards Compatible for Use with the Camcorder 31
  - Inserting and Removing a Memory Card 32
  - Initializing a Memory Card 32
  - Selecting the Memory Card for Recordings 33

- Selecting the Movie Format (AVCHD/MP4) 34

## 3 Recording 35

- Recording Movies and Photos 35
  - Recording in AUTO Mode 35
  - Recording in **M** (Manual) Mode 37
  - Reviewing the Latest Scene Recorded 39

- Selecting the Recording Mode (Video Quality) 40
- Dual Recording and Relay Recording 41
- Selecting the Frame Rate 42
- Slow & Fast Motion Recording 43
- CINEMA Mode and Cinema-Look Filters 45
- Focus Adjustment 47
  - Manual Focus 47
  - Autofocus 49
  - Face Detection & Tracking 50

- Zooming 52
  - Using the Focus/Zoom Ring 52
  - Using the Zoom Rockers 53
  - Using the Touch Screen's Zoom Controls 54
  - Soft Zoom Control 55
  - Digital Tele-Converter 55

- Advanced Image Stabilization 56
- Automatic Gain Control (AGC) Limit 57
- Automatic Exposure Recording Programs 58

- Exposure Adjustment 60
  - Using the Manual Exposure Recording Program 60
  - Exposure Compensation 61

- White Balance 63

- Special Scene Recording Programs 65
- Looks and Other Image Effects 67
  - Selecting a Look 67
  - Adjusting Picture Settings 67

- Setting the Time Code 69
  - Selecting the Running Mode 69
  - Selecting Drop Frame or Non-Drop Frame 70

- Setting the User Bit 71

- Recording Audio 72
  - Audio Settings and Recorded Audio Channels 72
  - Connecting an External Microphone or External Audio Input Source to the Camcorder 73
  - Using Line Input or an External Microphone Connected to an INPUT Terminal 73
  - Recording Audio to Channel 2 (CH2) 74
  - Audio Recording Level (INPUT Terminals) 74
  - Adjusting the Microphone's Sensitivity (INPUT terminals) 75

- Activating the Microphone's Attenuator (INPUT terminals) 75
- Using the Built-in Microphone or an External Microphone Connected to the MIC Terminal 76
- Switching the Input (MIC Terminal) Audio Scenes 76
- Audio Recording Level (Built-in Microphone/MIC Terminal) 77
- Microphone Directionality (Built-in Microphone) 78
- Audio Equalizer (Built-in Microphone) 79
- Wind Screen (Built-in Microphone) 79
- Microphone Attenuator (Built-in Microphone) 80
- Low Cut Filter (MIC Terminal) 80
- Microphone Attenuator (MIC Terminal) 81
- Using Headphones 82
- Color Bars/Audio Reference Signal 83
  - Recording Color Bars 83
  - Recording an Audio Reference Signal 83
- Video Snapshot 84
- Pre-Recording 85
- Onscreen Displays and Data Code 86
- Infrared Recording 87
  - Activating Infrared Mode 87
- Using the GP-E2 GPS Receiver 88
  - Connecting the GPS Receiver 88

## 4 Customization 90

- CUSTOM Dial and Button 90
- Assignable Buttons 91
  - Changing the Assigned Function 91
  - Using an Assignable Button 92
- Saving and Loading Menu Settings 93
  - Saving Menu Settings to a Memory Card 93
  - Loading Menu Settings from a Memory Card 93

## 5 Playback 94

- Playing Back Video 94
  - Adjusting the volume 95
  - Displaying scene information 96
  - Capturing Photos During Movie Playback 97

- Deleting Scenes 98
  - Deleting a Single Scene 98
  - Deleting Scenes from the Index Screen 98
- Dividing Scenes 100
- Trimming Scenes 101

## 6 External Connections 102

- Connecting to an External Monitor 102
  - Connection Diagram 102
  - XA15** Selecting the Terminal Used For Output 103
  - XA15** Using the HD/SD-SDI Terminal 103
    - Using the HDMI OUT Terminal 103
    - Using the AV OUT Terminal 104
- Audio Output 105
  - Synchronizing the Video with the Audio being Monitored 105
  - Selecting the Audio Channel 105

## 7 Photos 107

- Viewing Photos 107
  - Photo Jump Function 108
- Deleting Photos 109
  - Deleting a Single Photo 109
  - Deleting Photos from the Index Screen 109

## 8 Saving/Sharing Recordings 110

- Saving Movies to a Computer 110
  - Transferring Movies to the Computer 111
- Copying Recordings Between Memory Cards 112
  - Copying Scenes from the Movie Index Screen 112
  - Copying a Single Photo 112
  - Copying Photos from the Index Screen 113

Converting Movies to MP4 Format 114  
Copying Recordings to an External Video  
Recorder 115  
    In High Definition 115  
    In Standard Definition 115

## **9 Additional Information 117**

Appendix: Menu Options Lists 117  
    FUNC. Menu 117  
    Setup Menus 118

Appendix: Onscreen Icons and  
Displays 127

Troubleshooting 131  
    List of Messages 135

Safety Instructions and Handling

    Precautions 140  
    Camcorder 141  
    Battery Pack 142  
    Memory Card 142  
    Built-in Rechargeable Lithium  
    Battery 143  
    Disposal 143

Maintenance/Others 144

    Cleaning 144  
    Condensation 144  
    Viewing the Certification Logo 144  
    Using the Camcorder Abroad 145

Optional Accessories 146

Specifications 149

Reference Tables 152

    Approximate recording times 152  
    Approximate number of photos 152  
    Charging, Recording and Playback  
    Times 153

Index 155

---





# 1 Introduction

## About this Manual

Thank you for purchasing the Canon XA15 / XA11. Please read this manual carefully before you use the camcorder and retain it for future reference. Should your camcorder fail to operate correctly, refer to *Troubleshooting* (📖 131).

8

## Conventions Used in this Manual

-  **IMPORTANT**: Precautions related to the camcorder's operation.
-  **NOTES**: Additional topics that complement the basic operating procedures.
-  **POINTS TO CHECK**: Restrictions or requirements regarding the function described.
- : Reference page number within this manual.
- **XA15**: Used as an abbreviation for the model indicated in the icon. The icon refers to text and illustrations that apply only to the indicated model.
- The following terms are used in this manual:
  - “Memory card” refers to an SD, SDHC or SDXC memory card.
  - “Screen” refers to the LCD screen and the viewfinder screen.
  - “Scene” refers to one movie unit from the point you press the START/STOP button to start recording until you press again to pause the recording.
- The photos included in this manual are simulated pictures taken with a still camera. Unless indicated otherwise, illustrations and menu icons refer to the **XA15**.
- Some screenshots in this manual have been simplified to show only relevant icons.

### IMPORTANT

- Observe the following precautions while the camcorder's ACCESS indicator is on or flashing. Failing to do so may result in permanent data loss or damage to the memory.
  - Do not disconnect the power source or turn off the camcorder.
  - Do not open the double memory card slot cover.
  - Do not change the camcorder's camera mode.
  - Do not set the camcorder to MEDIA mode.
  - When a USB cable is connected to the camcorder, do not disconnect the USB cable.



The three sets of icons indicate the operating mode and whether a function is available in that mode.

**CAMERA** **MEDIA**: Indicates whether the camcorder is in shooting (CAMERA) or playback (MEDIA) mode. In this example, the function is available only in **CAMERA** mode. For details, refer to *Turning the Camcorder On and Off* (□ 24).

**AVCHD** **MP4**: Indicates the movie format. For details, refer to *Selecting the Movie Format (AVCHD/MP4)* (□ 34).

**AUTO** **M** **CINEMA**: Indicates the camera mode. For details, refer to *Setting the Camera Mode* (□ 25).

Focus Adjustment

### Autofocus

When autofocus is activated, the camcorder continuously adjusts the focus on the subject in the center of the screen. The focusing range is 1 cm (0.39 in.; at full wide-angle, measured from the front of the lens barrel) to ∞ and 60 cm (2 ft.; throughout the zoom range, measured from the front of the lens barrel) to ∞. Perform the following procedure to set the autofocus speed.

Operating modes: **CAMERA** **MEDIA** | **AVCHD** **MP4** | **AUTO** **M** **CINEMA**

- 1 **M** and **CINEMA** modes only: Press the AF/MF button.
- 2 Open the [AF Mode] screen.  
 [FUNC.] → [MENU] → [ ] → [AF Mode]
- 3 Touch the desired option and then touch [X].
  - The icon of the selected option appears on the screen.

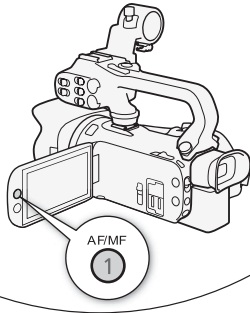

Brackets [ ] are used to refer to onscreen buttons and menu options you will select and to other onscreen messages and displays.

The **▶** arrow is used to abbreviate menu selections. For details on how to use the menus, refer to *Using the Menus* (□ 29). For a summary of available menu options and settings, refer to the appendix *Menu Options Lists* (□ 117).

## Supplied Accessories

The following accessories are supplied with the camcorder:

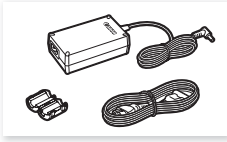

CA-570 Compact Power Adapter  
(incl. power cord and ferrite core)



BP-820 Battery Pack



Microphone holder unit  
(incl. screws)



Handle unit (incl. screws)



Lens hood with lens barrier



Lens cap



Quick Guide

## Names of Parts

## Left side view

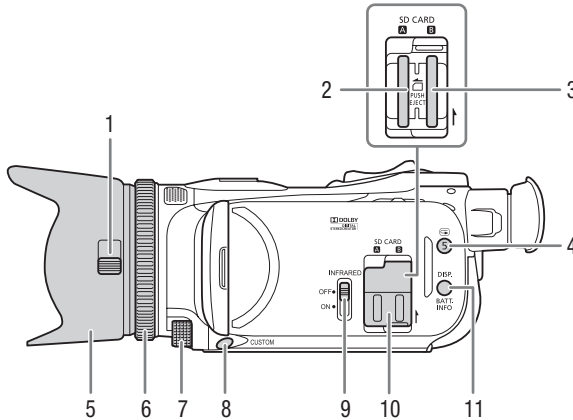

- |   |   |    |  |
|---|---|----|--|
| 1 | Lens barrier switch (  35)                                      | 5  | Lens hood (  20)   |
| 2 | Memory card slot <b>A</b> (  32)                                | 6  | Focus/Zoom ring (  47, 52)   |
| 3 | Memory card slot <b>B</b> (  32)                                | 7  | CUSTOM (customizable) dial (  90)  |
| 4 | (review recording) button (  39)/<br>Assignable button 5 (  91) | 8  | CUSTOM (customizable) button (  90)  |
| 5 | Lens hood (  20)  | 9  | INFRARED switch (  87)   |
| 6 | Focus/Zoom ring (  47, 52)                                      | 10 | Double memory card slot cover  |
| 7 | CUSTOM (customizable) dial (  90)                               | 11 | DISP. (onscreen display) button (  86)/BATT. INFO (battery information) button (  130) |

Right side view

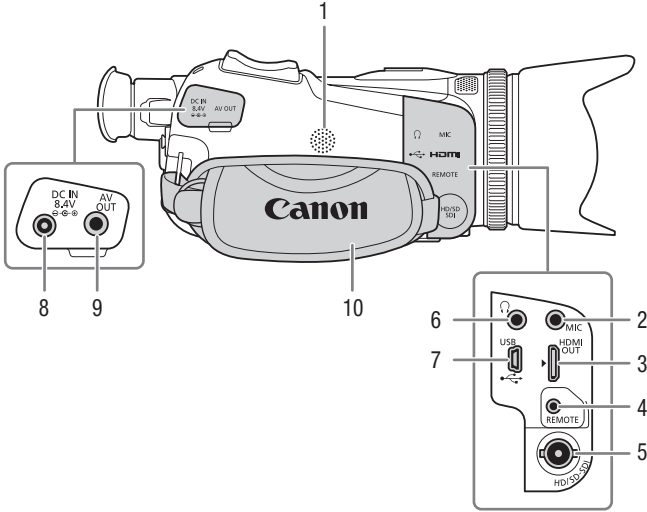

- 1 Built-in speaker (📖 95)
- 2 MIC terminal (📖 72)
- 3 HDMI OUT terminal (📖 102, 103)
- 4 REMOTE terminal  
For connecting commercially available remote controllers.

- 5 **XA15** HD/SD-SDI terminal (📖 103)
- 6 🎧 (headphones) terminal (📖 82)
- 7 USB terminal (📖 88)
- 8 DC IN terminal (📖 16)
- 9 AV OUT terminal (📖 102, 104)
- 10 Grip belt (📖 22)

## Front view

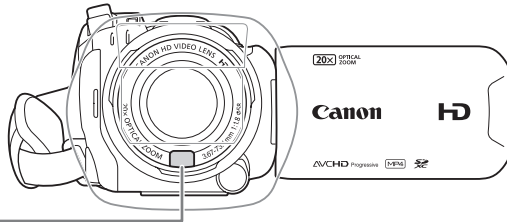

1

## Back view

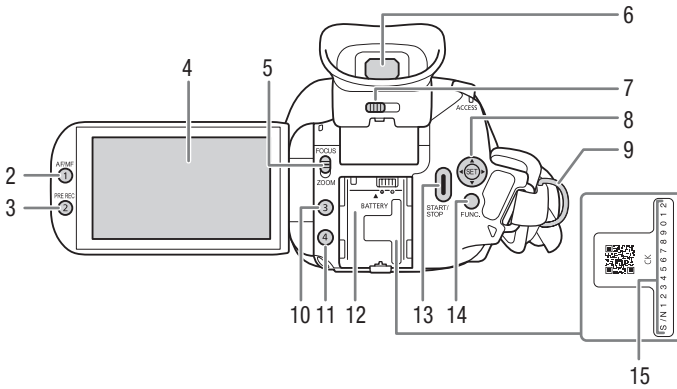

- |   |                                   |
|---|-----------------------------------|
| 1 Instant AF sensor ( 49, 144)  | 7 Diopter adjustment lever ( 20)  |
| 2 AF/MF button ( 47)/<br>Assignable button 1 ( 91)                      | 8 Joystick ( 26)/SET button ( 26) |
| 3 PRE REC (pre-recording) button<br>( 85)/<br>Assignable button 2 ( 91) | 9 Strap mount ( 22)               |
| 4 LCD touch screen ( 21, 25)  | 10 Assignable button 3 ( 91)      |
| 5 Focus/Zoom ring switch ( 47, 52)                                      | 11 Assignable button 4 ( 91)      |
| 6 Viewfinder ( 20)  | 12 Battery attachment unit ( 16)  |
|   | 13 START/STOP button ( 35)        |
|   | 14 FUNC. button ( 26)             |
|   | 15 Serial number                  |

Top view

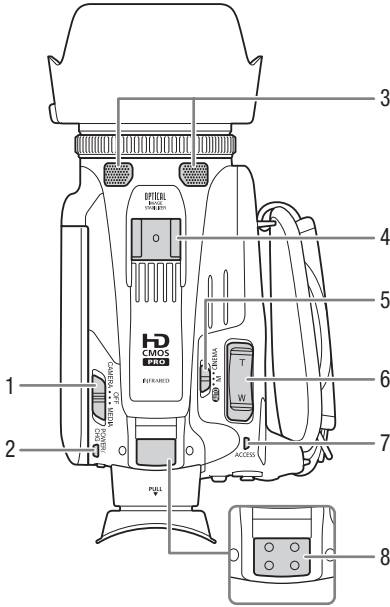

Bottom view

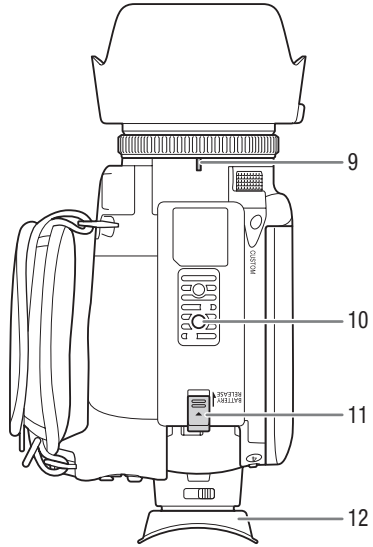

- 1 Power switch ( 24)
- 2 POWER / CHG (battery charging) indicator ( 16)
- 3 Built-in stereo microphone ( 72)
- 4 Accessory shoe
- 5 Mode switch ( 25)
- 6 Camcorder zoom rocker ( 53)
- 7 ACCESS indicator ( 35)

- 8 Handle unit mount ( 19)
- 9 Lens hood mount index mark
- 10 Tripod socket  
For mounting the camcorder on a tripod with a mounting screw 6.5 mm (0.26 in.) or shorter.
- 11 BATTERY RELEASE switch ( 17)
- 12 Eye cup ( 20)

## Handle unit

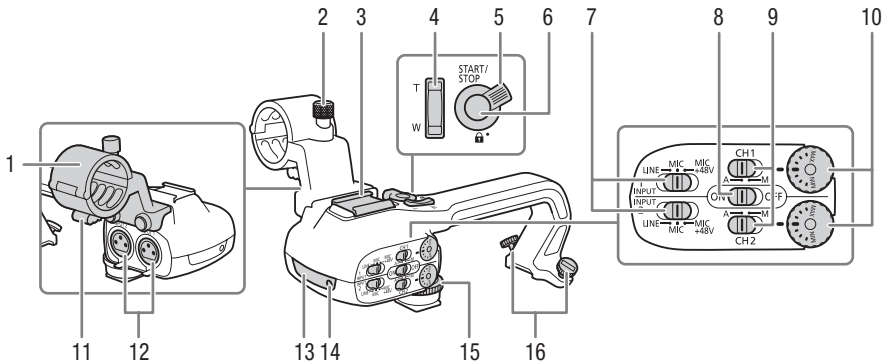

- |   |  |
|---|--|
| <p>1 Microphone holder unit ( 72)</p> <p>2 Microphone lock screw ( 72)</p> <p>3 Accessory shoe<br/>For attaching accessories.</p> <p>4 Handle zoom rocker ( 53)</p> <p>5 START/STOP lock ( 38)</p> <p>6 START/STOP button ( 35)</p> <p>7 Input selection switches for INPUT 1<br/>and INPUT 2 ( 73)</p> <p>8 INPUT terminal ON/OFF switch<br/>( 76)</p> | <p>9 Audio level switches for CH1 and<br/>CH2 ( 74)</p> <p>10 Audio level dials for CH1 and CH2<br/>( 74)</p> <p>11 Microphone cable clamp ( 72)</p> <p>12 INPUT 1 and INPUT 2 terminals<br/>(collectively referred to as "INPUT<br/>terminals") ( 73)</p> <p>13 Infrared light ( 87)</p> <p>14 Tally lamp ( 35)</p> <p>15 Handle unit front screw ( 19)</p> <p>16 Handle unit rear screws ( 19)</p> |
|---|--|

# 2 Preparations

## Attaching the Ferrite Core

Attach the enclosed ferrite core before you connect the compact power adapter to the camcorder. Attaching the ferrite core to the compact power adapter cable is necessary to suppress RF interference.

Attach the ferrite core to the cable about 6 cm (2.4 in.) from the DC plug (the plug to be connected to the DC IN terminal).

Pass the cable through the center of the core and wrap it around the core (as shown in the illustration), then close the unit until it clicks shut.

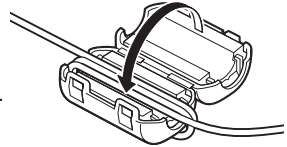

## Charging the Battery Pack

The camcorder can be powered with a battery pack or directly using the compact power adapter.

- 1 Connect the power cord to the compact power adapter.
- 2 Plug the power cord into a power outlet.
- 3 Connect the compact power adapter to the camcorder's DC IN terminal.

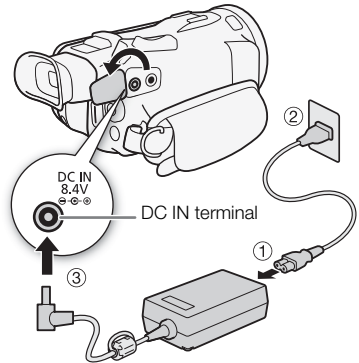

- 4 Attach the battery pack to the camcorder.

- Press the battery pack softly into the battery attachment unit and slide it forward until it clicks in place.

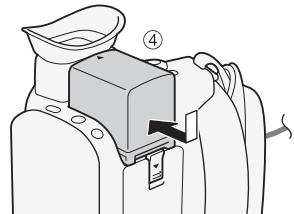



5 Charging will start when the camcorder is turned off.

- If the camcorder was on, the green POWER/CHG indicator will go out when you turn off the camcorder. After a moment, the POWER/CHG indicator will turn on in red (battery pack charging). The red POWER/CHG indicator will go out when the battery pack is fully charged.
- If the indicator flashes, refer to *Troubleshooting* (133).

POWER/CHG (battery charging) indicator

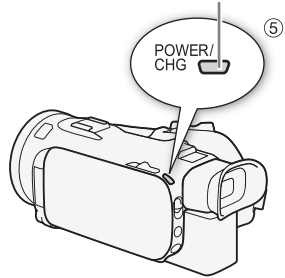

6 Disconnect the compact power adapter in the order shown in the illustration.

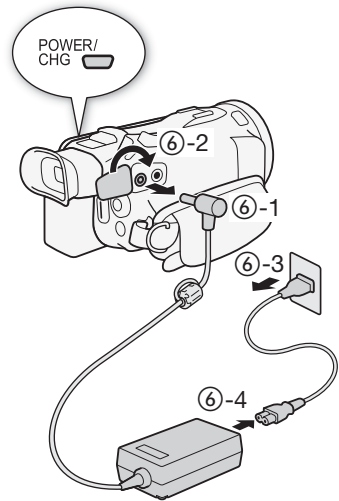

To remove the battery pack

- 1 Slide the BATTERY RELEASE switch in the direction of the arrow and hold it pressed down.
- 2 Slide the battery pack and then pull it out.

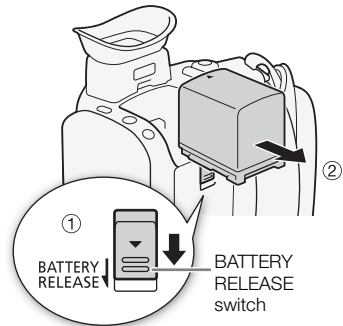

 IMPORTANT

- Turn off the camcorder before connecting or disconnecting the compact power adapter. After you turn off the camcorder, important data is updated on the memory card. Be sure to wait until the green POWER/CHG indicator goes out.
- When using the compact power adapter, do not fix it permanently to one place as this may cause a malfunction.
- Do not connect to the camcorder's DC IN terminal or to the compact power adapter any electrical equipment that is not expressly recommended for use with this camcorder.
- To prevent equipment breakdowns and excessive heating, do not connect the supplied compact power adapter to voltage converters for overseas travels or special power sources such as those on aircraft and ships, DC-AC inverters, etc.
- For details on how to take care of the battery pack, refer to *Safety Instructions and Handling Precautions* (📖 140).

18

 NOTES

- We recommend charging the battery pack in temperatures between 10 °C and 30 °C (50 °F and 86 °F). If either the ambient temperature or the battery pack's temperature is outside the range of approx. 0 °C to 40 °C (32 °F to 104 °F), charging will not start.
- The battery pack will be charged only when the camcorder is off.
- If the power supply was disconnected while charging a battery pack, make sure the POWER/CHG indicator has gone out before restoring the power supply.
- If remaining battery time is an issue, you can power the camcorder using the compact power adapter so the battery pack will not be consumed.
- Charged battery packs continue to discharge naturally. Therefore, charge them on the day of use, or the day before, to ensure a full charge.
- The first time you use a battery pack, fully charge it and then use the camcorder until the battery pack is completely exhausted. Doing so will ensure that the remaining recording time will be displayed accurately.
- We recommend that you prepare battery packs to last 2 to 3 times longer than you think you might need.
- For charging times and approximate usage times, refer to *Reference Tables* (📖 152).

## Preparing the Camcorder

This section covers the basic preparations for the camcorder such as attaching the handle unit and lens hood, and adjusting the viewfinder and LCD screen. When attaching the lens hood, grip belt and straps, be careful not to drop the camcorder by placing it on a table or other stable surface.

### Attaching the Microphone Holder Unit

Use the supplied screws to attach the microphone holder unit to the handle unit.

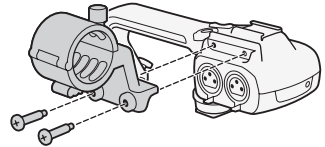

19

### Attaching the Handle Unit

1 Slide the front of the handle unit into the accessory shoe, as shown in the illustration. Then, slide the handle unit forward all the way.

- Make sure the front and rear screws are raised when you slide the handle unit.

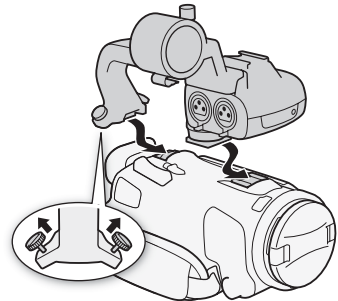

2 Turn the front screw and two rear screws to secure the handle unit.

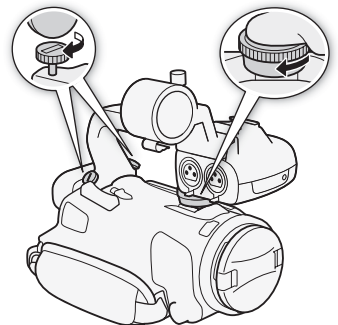

#### **i** NOTES

- The camcorder is functional even if you remove the handle unit. However, some audio options (□ 72), the infrared light and tally lamp will not be available.

## Using the Lens Hood and Lens Cap

While recording, the supplied lens hood with lens barrier is effective for reducing stray light that can be the cause of lens flare and ghost images. Additionally, closing the lens barrier can help prevent fingerprints and dirt accumulation on the lens.

- 1 Remove the lens cap.
  - 2 Align the mark on the lens hood with the lens hood mount index mark on the camera (①), and then turn the lens hood clockwise until it stops with a click (②).
- Be careful not to deform the lens hood.
  - Make sure that the lens hood is aligned with the thread.
  - To remove the lens hood, turn it counterclockwise.

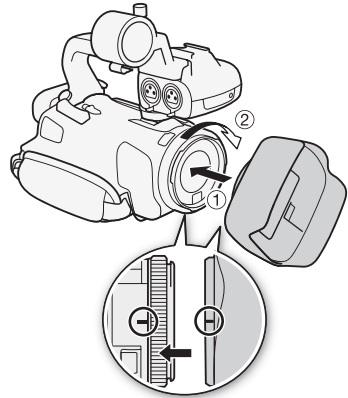

### **i** NOTES

- Use the supplied lens cap when carrying the camcorder or storing it after use.
- Note that the lens cap and the lens hood with lens barrier cannot be used simultaneously.

## Using the Viewfinder

If it is difficult to use the LCD screen, you can use the viewfinder, which can be tilted 45 degrees upward.

- 1 Close the LCD panel.
- 2 Pull out the viewfinder.
- 3 Use the power switch to turn on the camcorder.
- 4 Adjust the viewfinder using the dioptic adjustment lever.

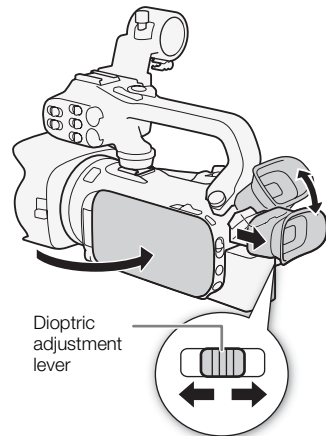

- If you wear glasses, you may find the viewfinder easier to use if you flip back the outer edge of the eye cup toward the camcorder body.

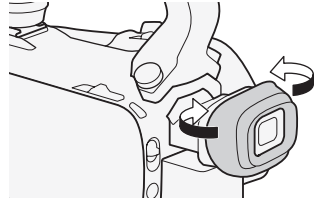

### **i** NOTES

- You cannot use the LCD screen and viewfinder simultaneously. To use the viewfinder, make sure you close the LCD panel.
- Make sure you keep the eye cup attached when using the camcorder.
- For details about how to take care of the viewfinder, refer to *Handling Precautions* (141), *Cleaning* (144).

## Adjusting the LCD Screen

Open the LCD panel 90 degrees.

- You can rotate the panel 90 degrees downward.
- You can rotate the panel 180 degrees toward the lens. Rotating the LCD toward the lens can be useful to allow the subject to monitor the LCD screen while you use the viewfinder.

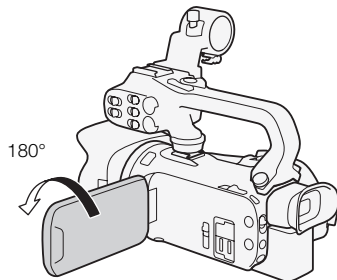
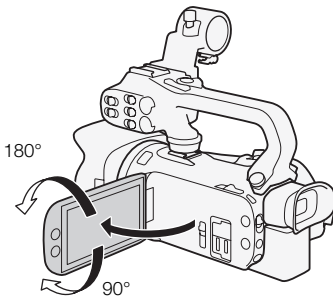

Subject can monitor the LCD screen  
(you can use the viewfinder at the same time)

### **i** NOTES

- You can adjust the brightness of the LCD screen with the [FUNC.] ➤ [MENU] ➤ [LCD Brightness] or [LCD Backlight] setting. Also, you can hold the DISP. button pressed down for more than 2 seconds to change the [LCD Backlight] setting between bright and normal. You can adjust the brightness of the viewfinder with the [FUNC.] ➤ [MENU] ➤ [Viewfinder Backlight] setting.
- Adjusting the brightness or using the [FUNC.] ➤ [MENU] ➤ [View Assistance] setting does not affect the brightness of recordings.
- Using a brighter setting will shorten the effective usage time of the battery pack.
- For details about how to take care of the LCD screen and viewfinder, refer to *Handling Precautions* (141), *Cleaning* (144).

- **About the LCD and viewfinder screens:** The screens are produced using extremely high-precision manufacturing techniques, with more than 99.99% of the pixels operating to specification. Very rarely, pixels may misfire or may light up permanently as white dots. This has no effect on the recorded image and does not constitute a malfunction.

## Grip Belt and Straps

### Fasten the grip belt.

- Adjust the grip belt so that you can reach the camcorder zoom rocker with your index finger, and the START/STOP button with your thumb.

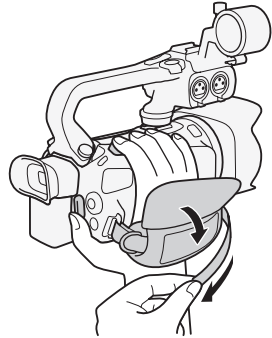

### Attaching an optional wrist strap

Attach the wrist strap to the strap mount on the grip belt, adjust the length and fasten.

- You can use both for extra convenience and protection.

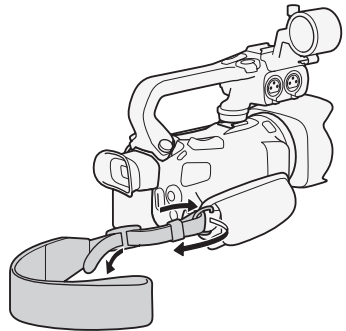

### Attaching an optional shoulder strap

Pass the ends of the shoulder strap through the strap mount on the grip belt and adjust the length of the strap.

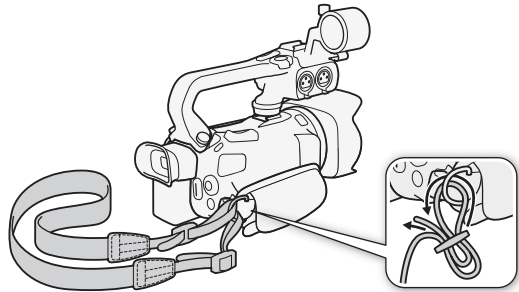

## Basic Operation of the Camcorder

### Turning the Camcorder On and Off

You can choose to turn the camcorder on in CAMERA (CAMERA) mode for making recordings or MEDIA (MEDIA) mode for playing back recordings. Select the mode using the power switch.

24

#### To turn on the camcorder

Set the power switch to CAMERA for CAMERA mode (35) or MEDIA for MEDIA mode (94).

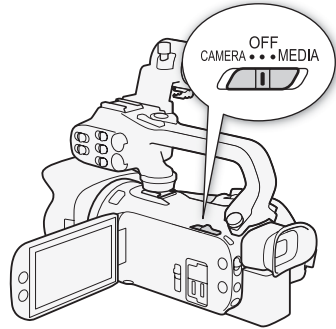
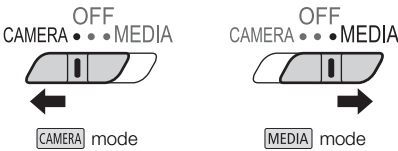

#### To turn off the camcorder

Set the power switch to OFF.

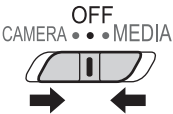



## Setting the Camera Mode

When making recordings, you can change the camera mode to match your shooting style.

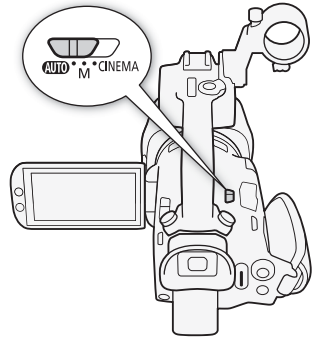

### **AUTO** (Auto) mode

Set the mode switch to **AUTO**. With this mode, the camcorder takes care of all the settings while you concentrate on recording (📖 35). This operating mode is suitable if you just prefer not to bother with detailed camcorder settings.



### **M** (Manual) mode

Set the mode switch to **M**. With this mode, you can enjoy full access to menus, settings and advanced functions (📖 37).



### **CINEMA** (Cinema) mode

Set the mode switch to **CINEMA**. With this mode, you can give your recordings a cinematic look and use cinema-look filters to create unique movies (📖 45).

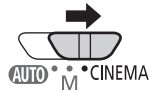

## Using the Touch Screen

The onscreen buttons and menu items that appear on the touch screen change dynamically depending on the operating mode and the task you are performing. With the intuitive touch screen interface you have all the controls at your fingertips.

### Touch

Press on an element displayed on the touch screen. Used to start playing back a scene in an index screen, to select a setting from the menus, etc.

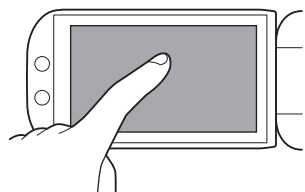

## Drag

Swipe your finger up and down or left and right across the screen. Used to scroll menus, to browse through index screen pages or to adjust slider controls like the volume. On some screens, you can achieve the same effect by touching the triangle onscreen buttons.

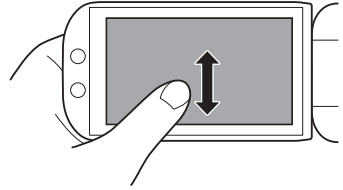

### ! IMPORTANT

- The camcorder features a capacitive touch screen. In the following cases, you may not be able to perform touch operations correctly.
  - Using your fingernails or hard-tipped objects, such as ballpoint pens.
  - Operating the touch screen with wet or gloved hands.
  - Applying excessive force or forcefully scratching the touch screen.
  - Attaching commercially available screen protectors or adhesive film onto the touch screen's surface.

## Using the FUNC. Button and Joystick

You can navigate some of the camcorder's menus and screens using the FUNC. button and joystick instead of using the touch panel.

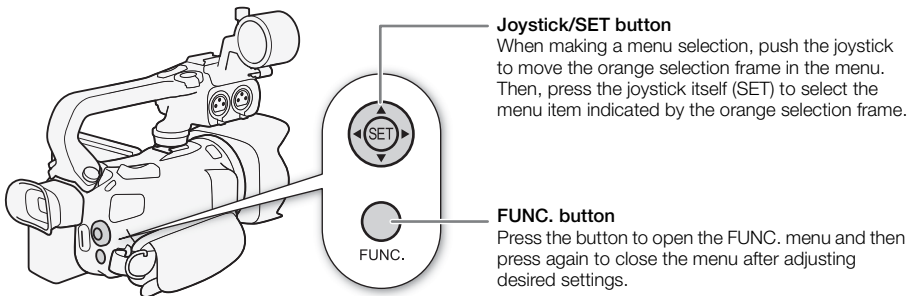

## First Time Settings

### Setting the Date and Time

You will need to set the date and time of the camcorder before you can start using it. The [Date/Time] screen will appear automatically when the camcorder's clock is not set.

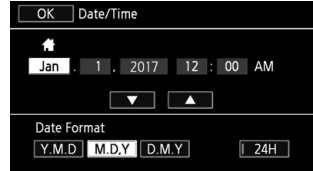



27

Operating modes: **CAMERA** **MEDIA** | **AVCHD** **MP4** | **AUTO** **M** **CINEMA**

- 1 Use the power switch to turn on the camcorder.
  - The [Date/Time] screen will appear.
- 2 Touch a field you want to change (year, month, day, hours or minutes).
  - You can also push the joystick (◀▶) to move between the fields.
- 3 Touch [▲] or [▼] to change the field as necessary.
  - You can also push the joystick (▲▼) to change the field.
- 4 Set the correct date and time by changing all the fields in the same way.
- 5 Touch [Y.M.D], [M.D,Y] or [D.M.Y] to select the date format you prefer.
  - In some screens, the date will be displayed in short form (numbers instead of month names or only the day and month), but it will still follow the order you selected.
- 6 Touch [24H] to use 24-hour clock or leave it unselected to use 12-hour clock (AM/PM).
- 7 Touch [OK] to start the clock and close the setup screen.

#### NOTES

- You can adjust the date and time later on with the [FUNC.] ➤ [MENU] ➤  ➤ [Date/Time] setting.
- When you do not use the camcorder for about 3 months, the built-in rechargeable lithium battery may discharge completely and the date and time setting may be lost. In such case, recharge the built-in lithium battery ( 143) and set the time zone, date and time again.

## Changing the Language

The default language of the camcorder is English. You can set it to one of 27 languages.

Refer to *Setup Menus* (📖 30) for details on how to navigate the menu for this procedure.



Operating modes: CAMERA MEDIA | AVCHD MP4 | AUTO M CINEMA

1 Open the [Language] screen.

[FUNC.] ➤ [MENU] ➤ [Language]

- Touching [FUNC.] is necessary only when performing the procedure in CAMERA mode.

2 Touch the desired language and then touch [OK].

3 Touch [X] to close the menu.

### **i** NOTES

- Some onscreen buttons, such as [ZOOM], [FUNC.] and [MENU], will appear in English regardless of the language selected.

## Changing the Time Zone

Change the time zone to match your location. The default setting is New York. In addition, the camcorder is able to retain the date and time of an additional location. This is convenient when you travel so that you can set the camcorder to match the time of your home location or that of your travel destination.

Refer to *Setup Menus* (📖 30) for details on how to navigate the menu for this procedure.

Operating modes: CAMERA MEDIA | AVCHD MP4 | AUTO M CINEMA

1 Open the [Time Zone/DST] screen.

[FUNC.] ➤ [MENU] ➤ [Time Zone/DST]

- Touching [FUNC.] is necessary only when performing the procedure in CAMERA mode.

2 Touch [🏠] to set the home time zone, or [✈️] to set the time zone of your destination when you are traveling.

3 Touch [▲] or [▼] to set the desired time zone. If necessary, touch [⌘] to adjust for daylight saving time.

4 Touch [X] to close the menu.

## Using the Menus

Many of the camcorder's functions can be adjusted from the FUNC. menu and the setup menus. For details about the available menu options and settings, refer to the appendix *Menu Options Lists* (117).

### FUNC. Menu

In **CAMERA** mode:

Operating modes: **CAMERA** **MEDIA** | **AVCHD** **MP4** | **AUTO** **M** **CINEMA**

There are three ways to access the FUNC. menu: by touching [FUNC.] on the screen, by pressing the FUNC. button or by pushing the joystick (▲▼/◀▶) to select [FUNC.] and then pressing the SET button. After the FUNC. menu is open, select the function you want to use. You may need to scroll up and down the screen or touch [▲]/[▼] to find the onscreen button of the desired function. In **AUTO** mode, access to functions is limited.

FUNC. menu in **M** mode

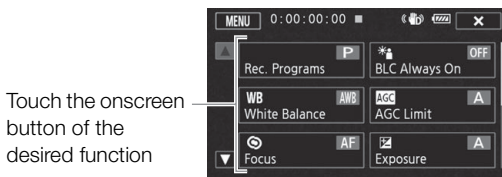

In **MEDIA** mode:

Operating modes: **CAMERA** **MEDIA** | **AVCHD** **MP4** | **AUTO** **M** **CINEMA**

Just like during **CAMERA** mode, you can open the FUNC. menu by touching [FUNC.] on the screen, by pressing the FUNC. button or by pushing the joystick (▲▼/◀▶) to select [FUNC.] and then pressing the SET button. After the FUNC. menu is open, select the function you want to use.

FUNC. menu in **MEDIA** mode

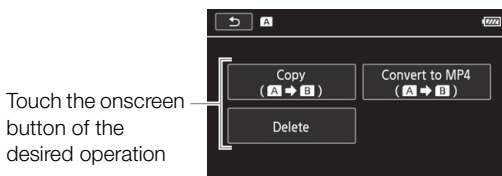

## Setup Menus

In this manual, navigating the setup menus is explained using the touch panel controls but they can also be navigated using the joystick and other buttons. The procedure below explains how to use both methods. If necessary, refer back to this section for details on using the joystick.

Operating modes: **CAMERA** **MEDIA** | **AVCHD** **MP4** | **AUTO** **M** **CINEMA**

### To use touch panel controls

- 1 **CAMERA** mode only: Touch [FUNC.].
- 2 Touch [MENU].
- 3 Touch the tab of the desired menu.
- 4 Drag your finger up and down to bring the desired setting into the orange selection bar.
  - You can also touch [▲] and [▼] to scroll up and down.
  - Menu items not available appear grayed out.
  - You can touch any menu item on the screen to bring it directly into the selection bar.
- 5 When the desired menu item is inside the selection bar, touch [▶].
- 6 Touch the desired option and then touch [✕].
  - You can touch [✕] to close the menu at any time.

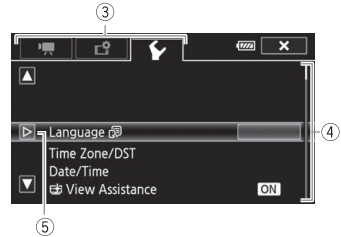

### To use the joystick

- 1 **CAMERA** mode only: Push the joystick (▲▼/◀▶) to select [FUNC.] and then press the SET button.
  - Alternatively, you can press the FUNC. button.
- 2 Push the joystick (▲▼/◀▶) to select [MENU] and then press the SET button.
- 3 Push the joystick (◀▶) to select the desired tab and then press the SET button.
- 4 Push the joystick (▲▼) to move the selection bar to the desired setting and then press the SET button.
  - Menu items not available appear grayed out.
- 5 Push the joystick (▲▼/◀▶) to select the desired option and then press the SET button.
- 6 Push the joystick (▲▼/◀▶) to select [✕] and then press the SET button.
  - You can press the FUNC. button to close the menu at any time.

### **i** NOTES

- For brevity's sake, references in the text to settings in the setup menus and functions in the FUNC. menu will include only a simplified way to show how to access them in the camcorder. For example, "You can adjust the date and time later on with the [FUNC.] ➤ [MENU] ➤ [Date/Time] setting." Note that in **MEDIA** mode, it is not necessary to select [FUNC.] for settings in the setup menus.

## Using a Memory Card

### Memory Cards Compatible for Use with the Camcorder

You can use the following types of commercially available Secure Digital (SD) cards with this camcorder. We recommend using memory cards rated CLASS 4, 6 or 10\*.

As of June 2017, the movie recording function has been tested using SD/SDHC/SDXC cards made by Panasonic, Toshiba and SanDisk. For the latest information about recording media tested for use with this camera, visit your local Canon Web site.

31

<p>Memory card type:  SD memory card,  SDHC memory card,  SDXC memory card</p> <p>SD Speed Class*:  CLASS 4  CLASS 6  CLASS 10</p>
--

\* When using an SD memory card without a speed class rating or one rated SD Speed Class 2, you may not be able to record movies, depending on the memory card used.

#### NOTES

- **About the Speed Class:** Speed Class is a standard that indicates the minimum guaranteed data transfer speed of memory cards. When you buy a new memory card, look for the Speed Class logo on the package.  
To record movies using a recording mode with a video quality of 28 Mbps or 35 Mbps, we recommend using memory cards rated SD Speed Class 6 or 10. To record movies using slow & fast motion, we recommend using memory cards rated SD Speed Class 10.

### SDXC Memory Cards

You can use SDXC memory cards with this camcorder. When using memory cards with other devices, such as digital recorders, computers and card readers, **make sure that the external device is compatible with SDXC cards**. For information about the compatibility of SDXC cards, contact the computer, operating system or memory card manufacturer.

#### IMPORTANT

- If you use an SDXC memory card with a computer OS that is not SDXC-compatible, you may be prompted to format the memory card. In such case, **cancel the operation to prevent data loss**.
- After repeatedly recording, deleting and editing clips (if the memory is fragmented), you may notice slower writing speeds to the recording media and recording may even stop. In such case, save your recordings and initialize the recording media with the camera (using the [Complete Initialization] option). Be sure to initialize recording media especially before shooting important scenes.

## Inserting and Removing a Memory Card

Make sure to initialize ( 32) all memory cards before using them with this camcorder.

### 1 Turn off the camcorder.

- Make sure the POWER/CHG indicator is off.

### 2 Open the double memory card slot cover.

### 3 Insert the memory card straight, with the label facing the front of the camcorder, all the way into one of the memory card slots.

- You can also use two memory cards, one in each memory card slot.

### 4 Close the double memory card slot cover.

- Do not force the cover closed if the memory card is not correctly inserted.

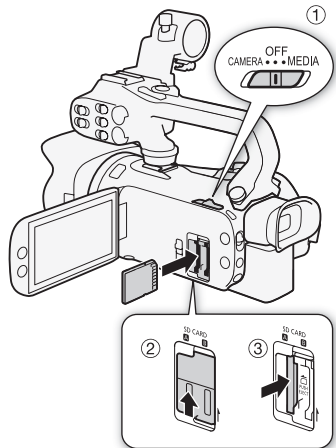

## To remove the memory card

Push the memory card once to release it. When the memory card springs out, pull it all the way out.

### ! IMPORTANT

- Turn off the camcorder before inserting or removing a memory card. Inserting or removing the memory card with the camcorder on may result in permanent data loss.
- Memory cards have front and back sides that are not interchangeable. Inserting a memory card facing the wrong direction can cause a malfunction of the camcorder. Be sure to insert the memory card as described in step 3.

## Initializing a Memory Card

Initialize memory cards when you use them with this camcorder for the first time. You can also initialize a memory card to permanently delete all the recordings it contains.

Operating modes: **CAMERA** **MEDIA** | **AVCHD** **MP4** | **AUTO** **M** **CINEMA**

### 1 Power the camcorder using the compact power adapter.

- Do not disconnect the power source or turn off the camcorder until the initialization is completed.

### 2 Open the initialization screen for the desired memory card.

[FUNC.] ➤ [MENU] ➤ [ ] ➤ [Initialize SD] ➤ [A] Mem. Card A] or [B] Mem. Card B] ➤ [Initialize]

- Touching [FUNC.] is necessary only when performing the procedure in **CAMERA** mode.
- In the initialization screen, touch [Complete Initialization] to physically erase all the data rather than just clear the file allocation table of the memory card.



**3 Touch [Yes].**

- If you selected the [Complete Initialization] option, you can touch [Cancel] to cancel the initialization while it is in progress. All recordings will be erased and the memory card can be used without any problem.

**4 Touch [OK] and then touch [X].****! IMPORTANT**

- Initializing a memory card will permanently erase all recordings. Lost original recordings cannot be recovered. Make sure you save important recordings in advance using an external device (□ 110).

**Selecting the Memory Card for Recordings**

Movies and photos are recorded on a memory card. You can select on which memory card your movies and photos will be recorded.

Operating modes: **CAMERA** **MEDIA** | **AVCHD** **MP4** | **AUTO** **M** **CINEMA**

**1 Open the [Recording Media] screen.**

[FUNC.] ➤ [MENU] ➤  ➤ [Recording Media]

**2 Touch the desired memory card ([A] Mem. Card A) or ([B] Mem. Card B) for recording movies ([🎥] Rec Media for Movies) or for taking photos ([📷] Rec Media for Photos).****3 Touch [X].**

- After closing the menu, the icon of the memory card selected for recording movies will appear on the screen.

## Selecting the Movie Format (AVCHD/MP4)

You can choose to record movies in AVCHD or MP4 format. AVCHD movies are ideal for playback with fantastic picture quality. MP4 movies are versatile and can easily be played back on smartphones and tablets or uploaded to the Web.

Operating modes:   |   |   

- 34
- 1 Open the [Movie Format] screen.  
[FUNC.] ➤ [MENU] ➤  ➤ [Movie Format]
  - 2 Select the desired movie format.
  - 3 Touch [X].
    - The icon of the selected movie format will appear on the screen.

# 3 Recording

## Recording Movies and Photos

You can select the memory card that will be used to record movies and photos (📖 33). For details on recording audio, refer to *Recording Audio* (📖 72). Should the camcorder fail to operate correctly, refer to *Troubleshooting* (📖 131).



### POINTS TO CHECK

- **Before you begin recording**, make a test recording first to check that the camcorder is operating correctly.

## Recording in AUTO Mode

When you use **AUTO** mode to shoot video and take photos, the camcorder will automatically adjust various settings for you.

Operating modes: **CAMERA** **MEDIA** | **AVCHD** **MP4** | **AUTO** **M** **CINEMA**

- 1 **Open the lens barrier.**
  - Set the lens barrier switch to OPEN.
- 2 **Set the mode switch to **AUTO**.**
- 3 **Set the power switch to CAMERA.**
  - The POWER/CHG indicator will illuminate in green.

### To record video

Press the **START/STOP** button to begin recording.

- During recording, **●** will appear on the screen. Additionally, if the handle unit is attached to the camcorder, the tally lamp will illuminate.
- The **ACCESS** indicator will flash from time to time while the scene is being recorded.
- Press the **START/STOP** button again to pause the recording. **●** will change to **■** and the scene will be recorded on the memory card selected for recording movies. The tally lamp will also go out.
- You can also press the **START/STOP** button on the handle unit.

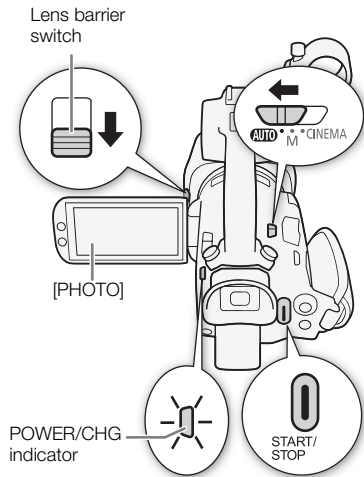

### To take photos

Touch **[PHOTO]**.

- In the lower center of the screen, a green icon (●) will appear. Also, in the upper right of the screen, **📷▶** will appear with the icon of the memory card selected for recording photos. The **ACCESS** indicator will flash as the photo is being recorded.













## When you have finished recording

- 1 Set the lens barrier switch to CLOSED to close the lens barrier.
- 2 Make sure that the ACCESS indicator is off.
- 3 Set the power switch to OFF.
- 4 Close the LCD panel and return the viewfinder to its retracted position.

## Smart AUTO

In **AUTO** mode, the camcorder will automatically detect certain characteristics of the subject, background, lighting conditions, etc. It will then adjust various settings (focus, exposure, color, image stabilization, image quality, among others), selecting the best settings for the scene you want to shoot. The Smart AUTO icon will change to one of the icons in the following table.

## Smart AUTO icons

Background (color of the icon) →	Bright <sup>1</sup> (gray)	Blue skies <sup>1</sup> (light blue)	Vivid colors <sup>1</sup> (yellow/green/ red)	Sunsets <sup>1</sup> (orange)
Subject ↓				
People (stationary)	 (  )	 (  )	 (  )	—
People (moving)	 (  )	 (  )	 (  )	—
Subjects other than people, such as landscapes	 (  )	 (  )	 (  )	
Close objects	 (  )	 (  )	 (  )	—

Background (color of the icon) →	Dark (dark blue)		
		Spotlight	Night scene
Subject ↓			
People (stationary)		—	—
People (moving)		—	—
Subjects other than people, such as landscapes			
Close objects	 	—	—





<sup>1</sup> The icon in parentheses appears under backlight conditions.

<sup>2</sup> This icon will appear under tele macro conditions. Tele macro is activated automatically when you zoom toward the telephoto end and close in on the subject. Tele macro allows you to get closer shots of small subjects and adds a soft focus to the background, so the subject not only looks larger but also stands out more.

- Under certain conditions, the Smart AUTO icon that appears on the screen may not match the actual scene. Especially when shooting against orange or blue backgrounds, the sunset or one of the blue skies icons may appear and the colors may not look natural. In such case, we recommend recording in **M** mode (📖 37).

## Intelligent IS

Intelligent IS allows the camcorder to select the best image stabilization option based on your shooting method. The Intelligent IS icon will change to one of the following icons. In **[M]** and **[CINEMA]** modes, you can set the image stabilization mode manually ( 56).

Shooting method	Icon
Most general situations; Zooming out (zooming toward <b>W</b> ); Following subjects at a distance moving left or right	 (Dynamic IS)
Zooming in (zooming toward <b>T</b> )	 (Powered IS)*
Close-up of a subject	 (Macro IS)
Remaining stationary, such as when using a tripod	 (Tripod mode)

\* With the [FUNC.] ➤ [MENU] ➤  ➤ [Intelligent IS] setting, you can select whether Powered IS can be set automatically as one of the Intelligent IS modes.

## Recording in **M** (Manual) Mode

In **[M]** mode, you can enjoy full access to the menus and manually adjust the exposure, focus, white balance and many more of the camcorder's settings to your preference. Even in **[M]** mode, though, the camcorder can help you with the settings, for example, by using Special Scene recording programs ( 65).

Operating modes: **[CAMERA]** **[MEDIA]** | **[AVCHD]** **[MP4]** | **[AUTO]** **[M]** **[CINEMA]**



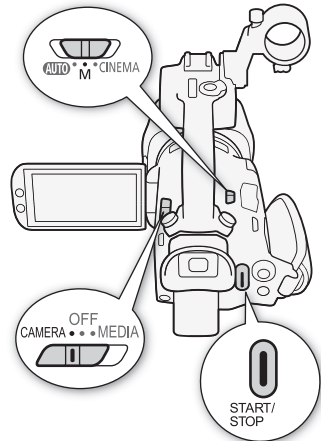













- 1 Set the mode switch to **M**.
- 2 Set the power switch to **CAMERA**.
  - The POWER/CHG indicator will illuminate in green.
- 3 Record movies and photos.
  - The procedure is the same as in **[AUTO]** mode ( 35).



### IMPORTANT

- Be sure to save your recordings regularly ( 110), especially after making important recordings. Canon shall not be liable for any loss or corruption of data.

 NOTES

- The START/STOP button on the handle unit has a lock lever to prevent accidental operation. Set the lock lever to  in cases such as when you do not want a recording inadvertently paused or do not plan to use this START/STOP button. Return the lever to its previous position to enable use of the START/STOP button again.
- When you set the [FUNC.]  [MENU]    [Rec Command] setting to [**ON** On] and you use the HD/SD-SDI terminal (**XA15** only) or HDMI OUT terminal to connect the camcorder to a device capable of receiving recording commands through a connection via the HD/SD-SDI terminal (**XA15** only) or HDMI OUT terminal, if you start or stop recording with the camcorder, the connected device will also start or stop recording. (When [Rec Command] is set to [**ON** On], video snapshot will not be available.)
- When the camcorder switches from recording on one memory card to another during relay recording, the video will be recorded as two separate relay scenes. With the software Data Import Utility, you can join relay scenes recorded on different memory cards as a single scene and save it on a computer ( 110).
- For scenes with a long recording time, the video (stream) file in a scene will be split approximately every 4 GB. Even in such case, playback will be continuous. With the software Data Import Utility, you can join such split files into a single scene and save it on a computer ( 110).
- When recording in bright places, it may be difficult to use the LCD screen. In such cases, you can adjust the brightness of the LCD screen with the [FUNC.]  [MENU]    [LCD Brightness] setting. Alternatively, you can also use the viewfinder ( 20).
- Photos are recorded as JPG files. During **AUTO** and **M** modes, the camcorder can take photos while recording a movie or during record standby mode. For the approximate number of photos that can be taken, refer to *Reference Tables* ( 152).
- Photos cannot be recorded during slow & fast motion recording mode or when [FUNC.]  [Image Effects]  [Looks] is set to [Highlight Priority].
- You can capture a photo from a scene during playback ( 97).
- When you need to record for a long time with the camcorder set on a tripod, you can close the LCD panel and use only the viewfinder in order to save power when using a battery pack ( 20).

## Reviewing the Latest Scene Recorded

You can review the last 4 seconds of the last scene recorded with the camcorder without switching to **MEDIA** mode. While reviewing the latest scene, the picture will be played back without sound. By default, assignable button 5 is set to **[REC REVIEW]** [Rec Review] but you can set another assignable button to this function (see 91).

Operating modes: **CAMERA** **MEDIA** | **AVCHD** **MP4** | **AUTO** **M** **CINEMA**

- 1 Record a scene.
- 2 After you finish recording a scene, press the **[5]** button.

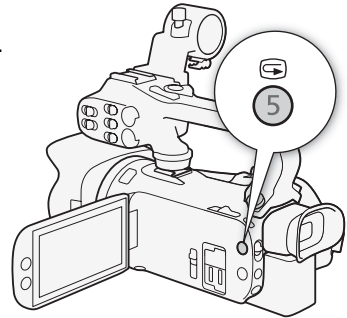

## Selecting the Recording Mode (Video Quality)

The camcorder offers various recording modes, depending on whether the movie format is AVCHD or MP4. When the recording mode of an AVCHD scene is set to 28 Mbps LPCM (59.94P) or 24 Mbps LPCM, you can enjoy two-channel linear PCM audio recording with a sampling frequency of 48 kHz. Refer to the following tables for details.

Operating modes: **CAMERA** **MEDIA** | **AVCHD** **MP4** | **AUTO** **M** **CINEMA**

1 Open the [Recording Mode] screen.

[FUNC.] ➤ [MENU] ➤ [📷] ➤ [Recording Mode]

2 Touch the desired recording mode and then touch [X].

### NOTES

- For details on approximate recording times, refer to *Approximate recording times* (📖 152).
- **About scenes recorded at [28 Mbps LPCM (59.94P)]/[28 Mbps (59.94P)] (AVCHD) or [35 Mbps (59.94P)]/[8 Mbps (59.94P)] (MP4):**
  - Recording such scenes is not available during **CINEMA** mode.
  - When recording such scenes, dual recording is not available.
  - Depending on the TV, scenes may not be able to be played back.
- AVCHD scenes recorded at 28 Mbps cannot be saved on AVCHD discs. Use an external Blu-ray Disc recorder compliant with AVCHD Ver. 2.0 specifications to copy those movies onto Blu-ray discs.
- The following types of MP4 scenes will be recognized as multiple files on other devices.
  - Scenes exceeding 4 GB
  - Scenes recorded at 35 Mbps or 8 Mbps exceeding 30 minutes
  - Scenes recorded with a recording mode other than 35 Mbps or 8 Mbps exceeding 1 hour

### Recording modes by movie format

Movie format	Recording mode	Resolution	Audio format
AVCHD	28 Mbps LPCM (59.94P)	1920x1080	Linear PCM
	28 Mbps (59.94P)		Dolby Digital
	24 Mbps LPCM		Linear PCM
	24 Mbps	1440x1080	Dolby Digital
	17 Mbps		
	5 Mbps		
MP4	35 Mbps (59.94P)	1920x1080	AAC
	24 Mbps		
	17 Mbps		
	8 Mbps (59.94P)	1280x720	
	4 Mbps		
	3 Mbps		



## Dual Recording and Relay Recording

When you record, you can use dual recording to record simultaneously on both memory cards. Alternatively, you can use relay recording so that if the memory card being recorded on becomes full, the recording will continue uninterrupted on the other memory card.

### Activating dual recording

The backup movie is recorded on memory card B. After you activate dual recording, select the backup movie's recording mode.

Operating modes: **CAMERA** **MEDIA** | **AVCHD** **MP4** | **AUTO** **M** **CINEMA**

#### 1 Open the [Dual Recording] screen.

[FUNC.] ➤ [MENU] ➤  ➤ [Dual/Relay Recording] ➤ [Dual Recording]

- The screen shows the movie format and recording mode of the movies that will be recorded on each card.

#### 2 Select the movie format and recording mode for the backup movie that will be recorded on memory card B.

- The first option is always the same movie format and recording mode of the movie that will be recorded on memory card A. The second two options are always **[MP4 4Mbps]** and **[MP4 3Mbps]**, which result in small files that are ideal for transferring to a computer.

#### 3 Touch [**X**].

### Activating relay recording

Operating modes: **CAMERA** **MEDIA** | **AVCHD** **MP4** | **AUTO** **M** **CINEMA**

#### 1 Open the [Dual/Relay Recording] screen.

[FUNC.] ➤ [MENU] ➤  ➤ [Dual/Relay Recording]

#### 2 Touch [Relay Recording] and then touch [**X**].

### NOTES

- To use neither function, select [Standard Recording] on the [Dual/Relay Recording] screen.
- When you use relay recording, it does not matter which memory card the recording starts on. The recording will continue on the other memory card. However, the camcorder will switch to another memory card only one time.
- With the software Data Import Utility, you can join relay scenes (either AVCHD or MP4 format) recorded on both memory cards as a single scene and save it on a computer ( 110).
- Dual recording is not available when the recording mode uses a frame rate of 59.94P.

## Selecting the Frame Rate

You can change the frame rate (the number of frames recorded per second) to change the look of your movies. When the recording mode is set to 28 Mbps LPCM (59.94P) or 28 Mbps (59.94P) for AVCHD movies, or 35 Mbps (59.94P) or 8 Mbps (59.94P) for MP4 movies, the frame rate will automatically be set to 59.94P so you will not be able to select the frame rate.

Operating modes: **CAMERA** **MEDIA** | **AVCHD** **MP4** | **AUTO** **M** **CINEMA**

1 Open the [Frame Rate] screen.

[FUNC.] ➤ [MENU] ➤  ➤ [Frame Rate]

2 Touch the desired frame rate and then touch [X].

### Options for AVCHD movies (♦ Default value)

**[59.94i 59.94i]♦** 59.94 fields per second, interlaced. Standard frame rate of TV signals.

**[PF29.97 PF29.97]** 29.97 frames per second, progressive\*.

**[23.98P 23.98P]** 23.98 frames per second, progressive.

\* Recorded as 59.94i.

### Options for MP4 movies (♦ Default value)

**[29.97P 29.97P]♦** 29.97 frames per second, progressive.

**[23.98P 23.98P]** 23.98 frames per second, progressive.

### NOTES

- The frame rate can be set independently for **M** and **CINEMA** modes.

## Slow & Fast Motion Recording

When the movie format is set to MP4, you can record scenes that have a slow motion or fast motion effect during playback. You simply select the slow motion or fast motion rate you are trying to achieve (x0.4 to x1200 the normal speed) and then record. Sound is not recorded for such scenes.



Operating modes: CAMERA MEDIA | AVCHD MP4 | AUTO M CINEMA

### 1 Open the [Slow & Fast Motion] screen.

[FUNC.] ➤ [MENU] ➤  ➤ [Slow & Fast Motion]

### 2 Select the desired rate.

### 3 Touch [X].

-  or  and the selected option will appear on the screen.
- To turn off slow & fast motion recording mode, repeat the procedure selecting [OFF] instead.

### 4 Press the START/STOP button to start recording.

- While recording, the time code's dividers (:) will flash. Note that the higher the rate used, the more slowly the time code will advance.

### 5 Press the START/STOP button again to stop recording.

- When recording with a fast motion effect, the camcorder will adjust the time code after the recording stops.

### Available Slow/Fast Motion Rates

Recording mode	Frame rate	Available slow/fast motion rates
35 Mbps (59.94P), 8 Mbps (59.94P)	—	x2, x2.5
24 Mbps, 17 Mbps	29.97P	x0.5, x1.25, x2, x4, x10, x20, x60, x120, x1200
	23.98P	x0.4, x0.8

### NOTES

- The following functions cannot be used with slow & fast motion recording mode:
  - Dual recording
  - Relay recording
  - Pre-recording mode
  - Video snapshot
  - Color bars
  - Face detection & tracking
- During slow & fast motion recording mode, the running mode of the time code ( 69) is set to [Rec Run] or [Regen.] and the time code will advance by the number of frames recorded. If you activate slow & fast motion recording mode while the running mode is set to [Free Run], the running mode will automatically change to [Rec Run]. When you end slow & fast motion recording mode, the running mode will return to its previous setting.
- When the recording mode is 35 Mbps (59.94P) or 8 Mbps (59.94P) and the slow/fast motion rate is x2 or x2.5, it may take approximately 1 second to stop recording.
- To record movies using slow & fast motion, we recommend using memory cards rated SD Speed Class 10.

- The amount of video that can be recorded at one time is approximately 12 hours' worth of video at normal playback speed. When that amount is exceeded, the camcorder will automatically stop recording. However, when you use slow & fast motion recording, the recording time will change. For example, when [x0.5] is selected, the recording time will be 6 hours (playback time will be 12 hours).

## CINEMA Mode and Cinema-Look Filters

In **CINEMA** mode, you can use a variety of professional cinema-look filters to create unique movies with a distinctive appearance. You can also use cinema-look filters when you convert movies to MP4 (📖 114).

Operating modes: **CAMERA** **MEDIA** | **AVCHD** **MP4** | **AUTO** **M** **CINEMA**

- 1 Set the mode switch to **CINEMA**.
- 2 Touch **[FILTER 1]** to open the cinema-look filter selection screen.
- 3 Drag your finger up and down along the photos to select the desired cinema-look filter and then touch **[OK]**.
  - You can change the effect level before touching **[OK]** (see below).
  - [Cinema Standard] offers different adjustment options than the other cinema-look filters.
  - The selected cinema-look filter will be applied and its number will appear in the onscreen button.

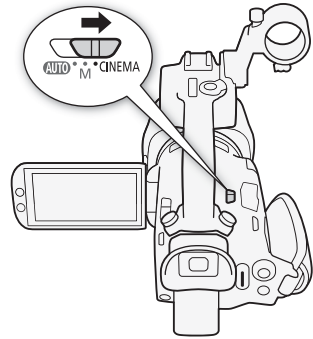

### To select the effect level of [Cinema Standard]

- 1 Open the parameter selection screen.
  - [👉] ➤ **[ON]**
- 2 Touch **[Color Depth]**, **[Softening Filter]**, **[Key (Brightness)]** or **[Contrast]**.
- 3 Touch the desired level or touch **[◀]** or **[▶]** to adjust the parameter.
  - You can also drag your finger along the dial.
  - The picture will change immediately according to the adjustment.
  - To adjust other parameters, touch **[↶]** to return to the previous screen. Touch the desired onscreen button and repeat step 3.
- 4 Touch **[↷]**.

### To select the effect level of the other cinema-look filters

- 1 Touch **[👉]** to open the adjustment screen.
- 2 Touch **[L]** (low), **[M]** (medium) or **[H]** (high).
- 3 Touch **[↷]**.

**Options** (♦ Default value)

The camcorder offers the following cinema-look filters. Select the desired filter while previewing the effect on the screen.

- [1. Cinema Standard]♦
- [2. Vivid]
- [3. Dream]
- [4. Cool]
- [5. Sepia]
- [6. Old Movies]
- [7. Memory]

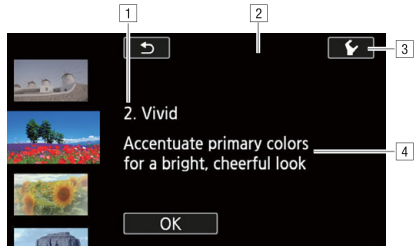

- 1 Filter number (will appear on the onscreen button) and name
- 2 Preview the effect on the screen
- 3 Select the effect level
- 4 Brief description (onscreen guidance)

**i** NOTES

- During **CINEMA** mode, the following functions are not available.
  - Taking photos
  - Dual recording
  - Using a recording mode that uses a frame rate of 59.94P.
  - Slow & fast motion recording mode
  - Infrared recording

## Focus Adjustment

The camcorder offers manual and automatic focus adjustment. When using manual focus, you can use the focus preset and peaking functions to assist you. When using automatic focus, you can use face detection & tracking to help make sure the subject is in focus.



### POINTS TO CHECK

- Adjust the zoom before you start the procedure.

## Manual Focus

Use the focus/zoom ring to focus manually. You can change the direction and sensitivity of the focus/zoom ring ( 125). Manual focus is available even after touching the screen to adjust the focus automatically.

Operating modes: **CAMERA** **MEDIA** | **AVCHD** **MP4** | **AUTO** **M** **CINEMA**

- Set the focus/zoom ring switch to FOCUS.

Focus/zoom ring

To focus using only the focus/zoom ring

- Press the AF/MF button.
  - [MF] will appear on the screen.
- Turn the focus/zoom ring to adjust the focus.

To focus by touching the subject on the screen

- Open the focus controls.
 

[FUNC.] ➤ [Focus]

  - The focus adjustment screen will appear.
- Touch a subject that appears inside the frame.
  - The Touch AF mark ( ) will flash and the focusing distance will be adjusted automatically.
  - To return the camcorder to autofocus, touch **MF**.
- If necessary, turn the focus/zoom ring to further adjust the focus.

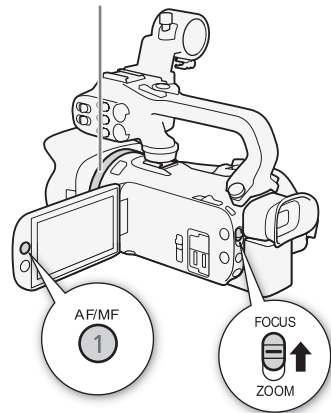

### NOTES

- The center of the screen will be magnified to help you focus more easily. You can also turn off this function with the [FUNC.] ➤ [MENU] ➤ ➤ [Focus Assistance] setting.
- The focusing distance displayed will change as you adjust the focus with the focus/zoom ring. You can change the units used for the distance display with the [FUNC.] ➤ [MENU] ➤ ➤ [Distance Units] setting.

## Focus Preset

When focusing manually, you can set a preset position for the focus in advance so that you can later return to that preset focus position instantly.

1 Open the focus/zoom controls.

[FUNC.] ➤ [👁 Focus]

2 Touch [MF].

3 Use Touch AF or turn the focus/zoom ring to obtain the desired focus position.

4 Touch [SET] to set the preset focus position.

5 After adjusting the focus, touch [ON] to return to the preset focus position.

- Touch [SET] again to cancel the current preset focus position.
- [ON] will be grayed out while adjusting the focus or zoom.
- You can use the [FUNC.] ➤ [MENU] ➤ [⏪] ➤ [Focus Preset Speed] setting to adjust the speed at which the camcorder returns to the preset focus position.

### NOTES

- The preset focus position will be canceled when the camcorder is turned off.

## Peaking

When peaking is activated, the edges of objects in focus will be highlighted in red, blue or yellow on the screen. In addition, you can choose to switch the screen to black & white, further emphasizing the edges.

1 Open the focus controls.

[FUNC.] ➤ [👁 Focus]

2 Touch [👁].

For the black & white setting: Touch [Off] or [On]

For the peaking color: Touch [Red], [Blue] or [Yellow]

3 Touch [👁].

4 Touch [PEAK].

- Peaking is activated and edges are highlighted. You can turn the focus/zoom ring on this screen or touch [X] to hide the focus controls.
- Touch [PEAK] again to turn off the peaking effect.

### NOTES

- The peaking effect and black & white picture will not appear in your recordings.



## Autofocus

When autofocus is activated, the camcorder continuously adjusts the focus on the subject in the center of the screen. The focusing range is 1 cm (0.39 in.; at full wide-angle, measured from the front of the lens barrel) to  $\infty$  and 60 cm (2 ft.; throughout the zoom range, measured from the front of the lens barrel) to  $\infty$ . Perform the following procedure to set the autofocus speed.

Operating modes: **CAMERA** **MEDIA** | **AVCHD** **MP4** | **AUTO** **M** **CINEMA**

- 1 **M** and **CINEMA** modes only: Press the AF/MF button.
- 2 Open the [AF Mode] screen.  
[FUNC.] ➤ [MENU] ➤  ➤ [AF Mode]
- 3 Touch the desired option and then touch **[X]**.
  - The icon of the selected option appears on the screen.

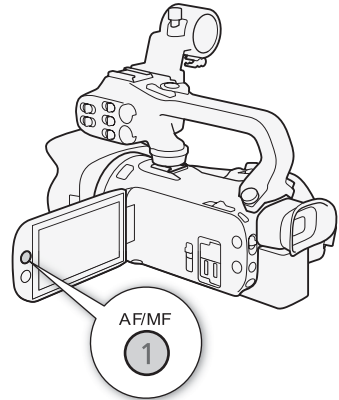



### Options <sup>(\*)</sup> Default value

**[LAF Instant AF]**<sup>\*</sup> Sets the autofocus to Instant AF. The focus is adjusted at the highest speed. This mode is useful even when recording in very bright or low-light surroundings. This mode uses both the TTL system and external sensor for focusing.

**[MAF Medium AF]** Sets the autofocus to Medium AF. The camcorder focuses more smoothly on the subject than when using the **[LAF Instant AF]** setting. This mode uses both the TTL system and external sensor for focusing.

**[AF Normal AF]** Sets the autofocus to Normal AF. The autofocus adjustment is made at a stable speed.

### NOTES

- When recording in bright surroundings, the camcorder closes down the aperture. This may cause the picture to appear blurred and is more noticeable toward the wide angle end of the zoom range. In such case, in **M** and **CINEMA** modes, select **[P Programmed AE]**, **[Tv Shutter-Pri. AE]**, **[Av Aperture-Pri. AE]** or **[M Manual Exposure]** recording program and set [FUNC.] ➤ [MENU] ➤  ➤ [ND Filter] to **[A Automatic]**.
- When you set [FUNC.] ➤ [MENU] ➤  ➤ [Conversion Lens] to a setting other than **[OFF Off]**, the **[LAF Instant AF]** and **[MAF Medium AF]** settings are not available.
- Autofocus takes longer to focus when the frame rate is PF29.97 or 23.98P than when it is 59.94P or 59.94i.
- When recording under dark conditions, the focusing range narrows and the picture may appear blurred.

- While using autofocus, you can turn the focus/zoom ring to focus manually. When you stop turning the ring, the camcorder returns to autofocus. This is useful in situations such as when focusing on a subject on the other side of a window.
- When the recording program is set to [🎆 Fireworks], the focus will be set to ∞ and cannot be changed.
- Autofocus may not work well on the following subjects or in the following cases. In such case, focus manually.
  - Reflective surfaces
  - Subjects with low contrast or without vertical lines
  - Fast moving subjects
  - When [FUNC.] ➤ [Image Effects] ➤ [Looks] is set to [Wide DR].
  - When subjects at different distances appear inside the AF frame.
  - Through dirty or wet windows
  - Night scenes

### Face Detection & Tracking



During autofocus, the camcorder automatically detects people’s faces and uses this information to select the optimal focus and exposure settings. When a face cannot be detected, the camcorder will adjust the focus using autofocus. When multiple faces are detected, you can use tracking to have the camcorder track and optimize settings for a different subject. You can also use tracking to optimize settings for moving subjects such as pets. You must use the touch screen to select the subject.

Operating modes: [CAMERA] [MEDIA] | [AVCHD] [MP4] | [AUTO] [M] [CINEMA]

#### POINTS TO CHECK

- Select a recording program other than [🌃 Night Scene], [🌑 Low Light] or [🎆 Fireworks].

By default, face detection & tracking are activated. If the function was turned off, perform the following procedure to turn it on.

- 1 Open the [Face Detection & Tracking] screen.  
[FUNC.] ➤ [MENU] ➤  ➤ [Face Detection & Tracking]
- 2 Touch [ON] On  and then touch [X].

#### To select the main subject

If there is more than one person in the picture, the camcorder will automatically select one person it determines is the main subject. The main subject is indicated by a white face-detection frame and the camcorder will optimize the settings for that person. Other faces will have gray frames.

Touch a different face on the touch screen to optimize the camcorder’s settings for that person.

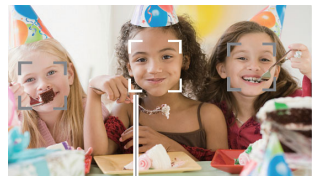

- You can also touch other moving objects, such as a pet.
- A white double frame will appear around the subject and track it as it moves.
- Touch [Cancel]  to remove the frame and cancel the tracking.



Main subject

## Limiting Autofocus to Faces

While using autofocus, you can limit the autofocus function only to cases when a subject's face is detected and use manual focus for all other scenes. The camcorder will also adjust the brightness when focusing automatically on the subject's face.

Set an assignable button to [ Face Only AF] ( 91) and press the button.

-  appears on the screen.

### NOTES

- The camcorder may mistakenly detect the faces of non-human subjects. In such case, turn face detection & tracking off.
- When face detection is activated, the slowest shutter speed used by the camcorder is 1/30 (1/24 if the frame rate is set to 23.98P).
- In certain cases, faces may not be detected correctly. Typical examples include:
  - Faces extremely small, large, dark or bright in relation to the overall picture.
  - Faces turned to the side, upside down, at a diagonal or partially hidden.
- Face detection & tracking cannot be used in the following cases.
  - When the shutter speed used is slower than 1/30 (1/24 if the frame rate is set to 23.98P).
  - When the digital zoom is activated at more than 80x zoom.
  - During infrared mode.
  - During fast & slow motion recording mode.
- Touching somewhere with a color or pattern unique to the subject will make it easier to track. However, if there is another subject in the vicinity that shares similar characteristics to the selected subject, the camcorder may start tracking the incorrect subject. Touch the screen again to select the desired subject.
- In certain cases, the camcorder may not be able to track the subject. Typical examples include:
  - Subjects extremely small or large in relation to the overall picture.
  - Subjects too similar to the background.
  - Subjects lacking sufficient contrast.
  - Fast moving subjects.
  - When shooting indoors with insufficient lighting.

## Zooming

Operating modes: **CAMERA** **MEDIA** | **AVCHD** **MP4** | **AUTO** **M** **CINEMA**

To zoom in and out, you can use the focus/zoom ring, the zoom rockers on the camcorder and handle unit, or the zoom controls on the touch screen.

In addition to the 20x optical zoom, you can turn on the digital zoom\* (400x) with the [FUNC.] ➤ [MENU] ➤ [Digital Zoom] setting.

This camcorder also features a digital tele-converter, which allows you to enlarge the image on the screen digitally.

\* Digital zoom is not available in **AUTO** mode or when [FUNC.] ➤ [MENU] ➤ [Conversion Lens] is set to [WA-H58].

### Using the Focus/Zoom Ring

- 1 Set the focus/zoom ring switch to **ZOOM**.
- 2 Turn the focus/zoom ring to adjust the zoom.
  - Turn the focus/zoom ring slowly for a slow zoom; turn it faster for faster zooms.
  - The zoom bar that appears on the screen indicates the approximate zoom position.

#### **i** NOTES

- If you turn the focus/zoom ring too quickly, the camcorder may not be able to zoom immediately. In such case, the camcorder will zoom after you finish turning the ring.

Focus/zoom ring

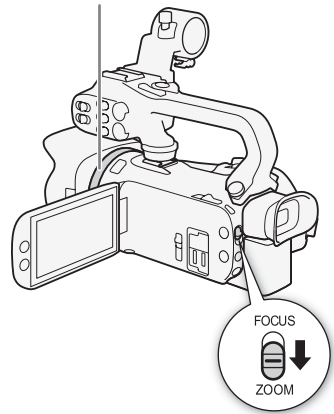

## Using the Zoom Rockers

Move the zoom rocker on the camcorder or handle unit toward **W** (wide angle) to zoom out. Move it toward **T** (telephoto) to zoom in.

- By default, the camcorder zoom rocker (the rocker near the grip belt) operates at a variable speed – press gently for a slow zoom; press harder for faster zooms. You can perform the following procedure to adjust the zoom speed and to select a constant speed.

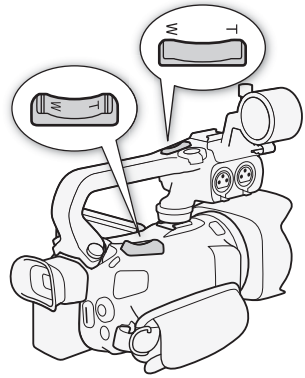

## Setting the Zoom Speed

You can set the zoom speed for the zoom rockers.

### To set the zoom speed of the camcorder zoom rocker

First, set the overall zoom speed to one of three levels. Next, select whether the zoom rocker operates at a constant or variable speed. Refer to the following table for a summary of the zoom speed.



- 1 Open the [Zoom Speed Level] screen.

[FUNC.] ➤ [MENU] ➤ [Zoom Speed Level]

- 2 Touch [Fast], [Normal] or [Slow] and then touch [↔].

- When [Zoom Speed Level] is set to [Fast], the sound made by the camcorder's internal machinery will increase and may be recorded in the scene.

- 3 Touch [Zoom Rocker Zoom Speed].

- 4 Touch [VAR] for variable speed or [CONST] for constant speed.

- If you selected [CONST], touch [↑] or [↓] or drag your finger along the bar to select a constant speed.

- 5 Touch [X].

Approximate zoom speeds\* (camcorder zoom rocker)

[Zoom Rocker Zoom Speed] setting	Selected constant speed	[Zoom Speed Level] setting		
		[Slow]	[Normal]	[Fast]
[VAR] (variable)	–	4 sec. to 4 min. 45 sec.	2.5 sec. to 3 min.	1.9 sec.** to 1 min.
[CONST] (constant)	1 (slowest)	4 min. 45 sec.	3 min.	1 min.
	16 (fastest)	4 sec.	2.5 sec.	1.9 sec.**

\* Measured from full wide-angle to full telephoto.

\*\* The camcorder will have more trouble focusing automatically while zooming.

### To use high-speed zoom

You can use high-speed zoom when [Zoom Rocker Zoom Speed] is set to [VAR]. When you use high-speed zoom, during record standby mode, [Zoom Speed Level] will be set to [Fast]. During recording, the zoom speed is determined by [Zoom Speed Level].

- 1 Open the [High-Speed Zoom] screen.  
[FUNC.] ➤ [MENU] ➤ [High-Speed Zoom]
- 2 Touch [ON On] and then touch [X].

54

### NOTES

- When pre-recording is activated during record standby mode, the zoom speed will be determined by the [Zoom Speed Level] setting.
- When you are using an external microphone while recording, the sound made by the camcorder's internal machinery while zooming may be recorded in the scene.

### To set the speed of the handle unit zoom rocker

For the zoom rocker on the handle unit, first set the overall zoom speed to one of three levels. The zoom rocker operates at a constant speed that you can select. To use the zoom rocker, make sure you attach the handle unit to the camcorder in advance. Refer to the following table for a summary of the zoom speed.

- 1 Open the [Zoom Speed Level] screen.  
[FUNC.] ➤ [MENU] ➤ [Zoom Speed Level]
- 2 Touch [Fast], [Normal] or [Slow] and then touch [↶].
  - When [Zoom Speed Level] is set to [Fast], the sound made by the camcorder's internal machinery will increase and may be recorded in the scene.
- 3 Touch [Handle Rocker Zoom Speed].
- 4 Touch [CONST].
  - Alternatively, you can touch [OFF] to turn off use of the zoom rocker.
- 5 Touch [↑] or [↓] or drag your finger along the bar to select a constant speed.
- 6 Touch [X].

### Approximate zoom speeds\* (handle unit zoom rocker)

Selected constant speed	[Zoom Speed Level] setting		
	[Slow]	[Normal]	[Fast]
1 (slowest)	4 min. 45 sec.	3 min.	1 min.
16 (fastest)	4 sec.	2.5 sec.	1.9 sec.**

\* Measured from full wide-angle to full telephoto.

\*\* The camcorder will have more trouble focusing automatically while zooming.

### Using the Touch Screen's Zoom Controls

- 1 Display the zoom controls on the touch screen.  
[FUNC.] ➤ [ZOOM]
  - The zoom controls appear on the left side of the screen.

## 2 Touch the zoom controls to operate the zoom.

- Touch anywhere within the **W** area to zoom out or anywhere within the **T** area to zoom in. Touch closer to the center for a slow zoom; touch closer to the **W/T** icons for faster zooms.

## 3 Touch **[X]** to hide the zoom controls.



## Soft Zoom Control

Soft zoom control allows you to start and/or stop the zoom gradually.

### 1 Open the [Soft Zoom Control] screen.

[FUNC.] ➤ [MENU] ➤ ➤ [Soft Zoom Control]

### 2 Touch the desired option and then touch **[X]**.

#### Options Default value)

**[OFF Off]** Use this setting if you do not intend to use soft zoom control.

**[START Start]** Zoom starts gradually.

**[STOP Stop]** Zoom stops gradually.

**[START/STOP Start & Stop]** Zoom start and stops gradually.

## Digital Tele-Converter

Using the digital tele-converter, you can digitally increase the focal length of the camcorder by a factor of approx. 2 and record the enlarged image.

Operating modes: **CAMERA** **MEDIA** | **AVCHD** **MP4** | **AUTO** **M** **CINEMA**

### 1 Open the [Digital Zoom] screen.

[FUNC.] ➤ [MENU] ➤ ➤ [Digital Zoom]

### 2 Touch **[20x Digital Tele-conv.]** and then touch **[X]**.

### 3 Open the zoom controls.

[FUNC.] ➤ [ZOOM]

### 4 Touch **[20x]** (digital tele-converter) and then touch **[X]**.

- The center of the screen will be enlarged approximately 2 times and the **[20x]** icon will appear.
- Touch **[20x]** again before closing the screen to deactivate the digital tele-converter.

#### NOTES

- You can attach the optional tele-converter and use it in conjunction with this function to increase the effect.
- The digital tele-converter cannot be set while recording or when [FUNC.] ➤ [MENU] ➤ ➤ [Conversion Lens] is set to [WA-H58].
- The image is digitally processed so the image will deteriorate throughout the zoom range.

## Advanced Image Stabilization

The image stabilizer reduces camcorder blur (blur due to the camcorder moving) so you can get nice, stable shots. Select the image stabilization mode according to the shooting conditions.

Operating modes: **CAMERA** **MEDIA** | **AVCHD** **MP4** | **AUTO** **M** **CINEMA**

1 Open the [Image Stabilizer] screen.

[FUNC.] ➤ [Image Stabilizer]

2 Touch the desired IS mode and then touch [X].

**Options** (♦ Default value)

**[Dynamic]♦** Compensates for a higher degree of camcorder shake, such as when shooting while walking, and is more effective as the zoom approaches full wide angle.

**[Standard]** Compensates for a lower degree of camcorder shake, such as when shooting while remaining stationary, and is suitable for shooting natural-looking scenes.

**[Off]** Use this setting when the camcorder is mounted on a tripod.

### Powered IS

After setting an assignable button to [Powered IS], you can use Powered IS to make the image stabilization even more powerful. Powered IS is most effective when you are stationary and zooming in on far subjects using high zoom ratios (the more you approach the telephoto end). Holding the LCD panel with your left hand will add to the stability of the shot.

Operating modes: **CAMERA** **MEDIA** | **AVCHD** **MP4** | **AUTO** **M** **CINEMA**

1 Set an assignable button to [Powered IS] (91).

2 Press and hold the assignable button as long as you want to activate Powered IS.

- [Powered IS] appears in yellow while Powered IS is activated.
- You can change the operation of the assignable button set to [Powered IS] (long press or toggle on/off) with the [FUNC.] ➤ [MENU] ➤ [ ] ➤ [Powered IS Button] setting.
- Powered IS is available even when [Image Stabilizer] is set to [Off].

### **i** NOTES

- If the degree of camcorder shake is too high, the image stabilizer may not be able to fully compensate.
- For surveying and following shots, when you pan the camcorder from side to side or tilt it up and down, we recommend setting [Image Stabilizer] to [Dynamic] or [Standard].
- The angle of view will change when [Image Stabilizer] is set to [Dynamic].



## Automatic Gain Control (AGC) Limit

When recording in dark surroundings, the camcorder will automatically increase the gain to try to get a brighter picture. However, using higher gain values may result in more noticeable video noise. You can select the AGC limit to curb the amount of noise by setting the maximum gain value to be used. The smaller the AGC limit, the darker the picture but the less noise it will contain.

Operating modes: **CAMERA** **MEDIA** | **AVCHD** **MP4** | **AUTO** **M** **CINEMA**



### POINTS TO CHECK

- Select a recording program other than the Special Scene recording programs or [**M** Manual Exposure].
- 1 Open the AGC limit adjustment screen.  
[FUNC.] ➤ [**AGC** AGC Limit] ➤ [**M**] (manual)
    - Touch [**A**] (automatic) to remove the AGC limit.
  - 2 Touch [**◀**] or [**▶**] to set the AGC limit.
    - You can also drag your finger along the dial.
  - 3 Touch [**X**].
    - The selected AGC limit will appear on the screen.



### NOTES

- Setting the AGC limit is not available in the following cases.
  - When [FUNC.] ➤ [**EX** Exposure] is set to [**M**].
  - During infrared mode.
- When the [FUNC.] ➤ [Image Effects] ➤ [Looks] setting is set to [Wide DR], note the following.
  - The lowest available setting for the AGC limit is 6 dB.
  - If [Image Effects] is switched between [ON] and [OFF], or [Looks] is changed from [Wide DR] to another option, [**AGC** AGC Limit] will be set to [**A**], regardless of the previous setting.
- If you set [FUNC.] ➤ [MENU] ➤ [**CD**] ➤ [CUSTOM Dial & Button] to [**AGC** AGC Limit] (**90**), you can adjust the AGC limit with the CUSTOM dial and button.

## Automatic Exposure Recording Programs

With the automatic exposure (AE) recording programs, the camcorder will adjust some camera-related settings to obtain the optimal exposure. When using the AE recording programs, you can change functions like the white balance and image effects.

Operating modes: **CAMERA** **MEDIA** | **AVCHD** **MP4** | **AUTO** **M** **CINEMA**

1 Open the screen of the desired recording program.

[FUNC.] ➤ [Rec. Programs] ➤ [**TV** Shutter-Pri. AE] or [**Av** Aperture-Pri. AE]

2 Touch [**◀**] or [**▶**] to set the desired shutter speed (**TV**) or aperture value (**Av**) and then touch [**✕**].

- You can also drag your finger along the dial.
- The selected shutter speed or aperture value will appear on the screen next to the recording program icon.

### Options <sup>(♦ Default value)</sup>

**[P Programmed AE]♦** The camcorder automatically adjusts the aperture and shutter speed to obtain the optimal exposure for the subject.

**[TV Shutter-Pri. AE]** Set the shutter speed value. The camcorder automatically sets the appropriate aperture value.

**[Av Aperture-Pri. AE]** Set the aperture value. The camcorder automatically sets the appropriate shutter speed.

### Available shutter speed settings

[1/8]	[1/15]	[1/30]	[1/60]	[1/100]
[1/250]	[1/500]	[1/1000]	[1/2000]	

### Available shutter speed settings when the frame rate is set to 23.98P

[1/6]	[1/12]	[1/24]	[1/48]	[1/60]
[1/100]	[1/250]	[1/500]	[1/1000]	[1/2000]



### Available aperture value settings

ND filter settings will be available when the aperture value is [F4.0].

[F1.8]	[F2.0]	[F2.2]	[F2.4]	[F2.6]	[F2.8]
[F3.2]	[F3.4]	[F3.7]	[F4.0]	[F4.4]	[F4.8]
[F5.2]	[F5.6]	[F6.2]	[F6.7]	[F7.3]	[F8.0]

### NOTES

- [**TV** Shutter-Pri. AE]:
  - On screen only the denominator is displayed – [**TV** 250] indicates a shutter speed of 1/250 second, etc.
  - When recording in dark surroundings, you can obtain a brighter picture by using slow shutter speeds; however, image quality may not be as good and autofocus may not work well.

- The image may flicker when recording with fast shutter speeds.
- **Recording movies under fluorescent lights:** If the screen starts to flicker, select [TV Shutter-Pri. AE] and set the shutter speed to 1/100.
- [Av Aperture-Pri. AE]: The actual range of values available for selection will vary depending on the initial zoom position.
- When setting a numeric value (aperture or shutter speed), the number displayed will flash if the aperture value or shutter speed is not appropriate for the recording conditions. In such case, select a different value.
- During exposure lock, the aperture value/shutter speed cannot be changed. Set the aperture value or shutter speed before manually adjusting the exposure.
- If you set [FUNC.] ➤ [MENU] ➤  ➤ [CUSTOM Dial & Button] to [ Tv / Av] ( 90), you can adjust the shutter speed or aperture value with the CUSTOM dial and button.

## Exposure Adjustment

At times, backlit subjects may appear too dark (underexposed) or subjects under very strong lights may appear too bright or glaring (overexposed). In such cases, adjusting the exposure will correct this. This camcorder features a dedicated recording program, [**M** Manual Exposure], for adjusting the exposure manually. However, you can also compensate the exposure when using other recording programs.

### Using the Manual Exposure Recording Program

Using the [**M** Manual Exposure] recording program, you can adjust the aperture, shutter speed and gain to achieve the desired exposure.

Operating modes: **CAMERA** **MEDIA** | **AVCHD** **MP4** | **AUTO** **M** **CINEMA**

1 Activate the [**M** Manual Exposure] recording program.

[FUNC.] ➤ [Rec. Programs] ➤ [**M** Manual Exposure]

- The exposure adjustment screen appears.

2 Touch the onscreen button of the setting you wish to adjust.

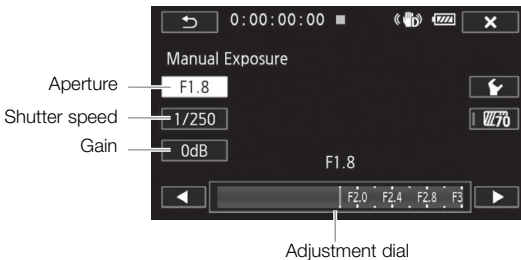

3 Touch [◀] or [▶] to set the desired value.

- You can also drag your finger along the dial.
- The exposure will change according to the setting's new value. Repeat steps 2 and 3 to adjust other settings.
- Before touching [✕], you can also use the zebra pattern (see below).

4 Touch [✕].

#### **i** NOTES

- When the [FUNC.] ➤ [Image Effects] ➤ [Looks] setting is set to [Wide DR], the lowest available gain setting is 6 dB.
- If you set [FUNC.] ➤ [MENU] ➤ [CUSTOM Dial & Button] to [**M** Manual Exposure] (📖 90), you can adjust the aperture, shutter speed and gain with the CUSTOM dial and button.

## Using the Zebra Pattern

You can use the zebra pattern to identify areas that might be overexposed, so you can correct the exposure appropriately. The camcorder offers two levels of zebra pattern: With 100% only areas that will lose detail in the highlight areas will be identified, while 70% will identify also areas that are dangerously close to losing detail.

- 1 From the exposure adjustment screen (📷 60), touch [👉] to select the zebra level.
- 2 Touch [70%] or [100%] and then touch [➡].
- 3 Touch [🚧70] or [🚧100] and then touch [✖].
  - The zebra pattern will appear on the overexposed areas of the picture.
  - Touch again to turn off the zebra pattern.

### NOTES

- Using the zebra pattern will not affect your recordings.

## Exposure Compensation

When you use a recording program other than [🎆 Fireworks] or [M Manual Exposure], the camcorder will adjust the exposure automatically. However, you can compensate and lock the exposure or use the Touch AE function to automatically set the optimal exposure for the subject you select. This is convenient when the brightness of the subject you want to shoot is noticeably brighter/darker than the general brightness of the image.

Operating modes: CAMERA MEDIA | AVCHD MP4 | AUTO M CINEMA



### POINTS TO CHECK

- Select a recording program other than [🎆 Fireworks] or [M Manual Exposure].
- 1 Open the exposure adjustment screen.
 

[FUNC.] ➡ [📷 Exposure]

    - The exposure adjustment screen appears.
  - 2 Touch a subject that appears inside the  frame.
    - The Touch AE mark (👉) will flash and the exposure will be adjusted automatically so the area you touched will be correctly exposed. You have the option to further adjust the exposure manually as necessary. Depending on the subject, you may want to use the [Highlights] setting as described below.
    - You can touch [M] instead to compensate the exposure without activating the Touch AE function.
    - The manual adjustment dial appears and the adjustment value is set at ±0.
    - Touch [M] again to return the camcorder to automatic exposure.
  - 3 Touch [◀] or [▶] or drag your finger along the dial to set the exposure compensation value.
    - The adjustment range may vary depending on the initial brightness of the image, and some values may be grayed out.
    - Before touching [✖], you can also use the zebra pattern (📷 61).

4 Touch [X] to lock the exposure at the selected value.

- During exposure lock, [AE] and the selected exposure compensation value will appear on the screen.

**i** NOTES

- Setting the exposure compensation is not available during infrared mode.
- The camcorder will return to automatic exposure if the camcorder is turned off, the power switch is operated, or the camera mode or recording program is changed.
- If you set [FUNC.] ➤ [MENU] ➤ [AE] ➤ [CUSTOM Dial & Button] to [AE Exposure] (p 90), you can adjust the exposure compensation value with the CUSTOM dial and button.

**To adjust the Touch AE function for highlights (Highlight AE)**

Certain subjects, like clouds or white objects, are easily overexposed and can end up appearing as bright areas where all detail is lost. Using the [Highlights] setting, you can touch the brightest area inside the [AE] frame and the camcorder will automatically make corrections so that area is not overexposed. When you touch a dark area in the picture or the highlights are too bright, the camcorder may not be able to correctly adjust the exposure.

After step 1 above:

- 1 Touch [AE].
- 2 Touch [Highlights] and then touch [AE].
  - Touch [Normal] to return the camcorder to normal Touch AE settings.

**To use backlight correction**

When recording in situations in which the subject is constantly backlit, you can use backlight correction to make the entire picture brighter, especially dark areas.

- 1 Open the [\* BLC Always On] screen.  
[FUNC.] ➤ [\* BLC Always On]
- 2 Touch [ON] and then touch [X].
  - [\*] appears on the screen.
  - Touch [OFF] to turn off backlight correction.
  - Alternatively, you can set an assignable button to [\* BLC Always On] (p 91). In that case, press the assignable button to turn the backlight correction on and off.

**i** NOTES

- Backlight correction cannot be used in the following cases.
  - When the recording program is set to [\* Fireworks].
  - When [FUNC.] ➤ [Image Effects] ➤ [Looks] is set to [Wide DR].
- This camcorder also has an automatic backlight correction feature with the [FUNC.] ➤ [MENU] ➤ [AE] ➤ [Auto Backlight Correction] setting.

## White Balance

The white balance function helps you to accurately reproduce colors under different lighting conditions.

Operating modes: **CAMERA** **MEDIA** | **AVCHD** **MP4** | **AUTO** **M** **CINEMA**



### POINTS TO CHECK

- Select a recording program other than the Special Scene recording programs.

#### 1 Open the white balance screen.

[FUNC.] ➤ [WB White Balance]

#### 2 Touch the desired option and then touch [X].

- When you select [**K** Color Temperature], [**1** Set 1] or [**2** Set 2], set the color temperature or a custom white balance with the appropriate procedure below before touching [X].
- The icon of the selected option will appear on the screen.

#### To set the color temperature ([**K** Color Temperature])

Touch [◀] or [▶] to set the desired value.

- You can also drag your finger along the dial.

#### To set a custom white balance ([**1** Set 1] or [**2** Set 2])

##### 1 Point the camcorder at a gray card or white object so it fills the entire screen.

##### 2 Touch [Set WB].

- When the adjustment is completed, stops flashing and disappears. The camcorder will retain the custom white balance even if you turn it off.

#### Options (♦ Default value)

[**AWB Automatic**]♦ The camcorder automatically sets the white balance for natural looking colors.

[ **Daylight**] To record outdoors on a bright day.

[ **Shade**] To record in shaded places.

[ **Cloudy**] To record on a cloudy day.

[ **Fluorescent**] To record under warm white, cool white or warm-white-type (3-wavelength) fluorescent lighting.

[ **Fluorescent H**] To record under daylight or daylight-type (3-wavelength) fluorescent lighting.

[ **Tungsten**] To record under tungsten and tungsten-type (3-wavelength) fluorescent lighting.

[**K Color Temperature**] Allows you to set the color temperature between 2,000 K and 15,000 K.



[**1 Set 1**], [**2 Set 2**] Use the custom white balance settings to make white subjects appear white under colored lighting.



### NOTES

#### • When you select a custom white balance:

- Set [FUNC.] ➤ [MENU] ➤ [] ➤ [Digital Zoom] to [**OFF** Off].
- Reset the white balance when you change locations or the lighting or other conditions change.
- Depending on the light source, may keep flashing. The result will still be better than with [**AWB Automatic**].

- Using a custom white balance may provide better results in the following cases:
  - Changing lighting conditions
  - Close-ups
  - Subjects in a single color (sky, sea or forest)
  - Under mercury lamps, certain types of fluorescent lights and LED lights
- Depending on the type of fluorescent light, optimal color balance may not be obtained with [ Fluorescent] or [ Fluorescent H]. If the color looks unnatural, select [**AWB** Automatic] or a custom white balance setting.



## Special Scene Recording Programs

Recording in a very bright ski resort or capturing the full colors of a sunset or a fireworks display becomes as easy as selecting a Special Scene recording program.

Operating modes: **CAMERA** **MEDIA** | **AVCHD** **MP4** | **AUTO** **M** **CINEMA**

### 1 Open the recording programs screen.

[FUNC.] ➤ [Rec. Programs] ➤ [Portrait]

### 2 Touch the desired recording program and then touch [X].

#### Options (Default value)

[Portrait] The camcorder uses a large aperture, to achieve a sharp focus on the subject while blurring the background.



[Sports] To record scenes with lots of movement.



[Night Scene] To record nightscapes with lower noise.



[Snow] To record in bright ski resorts without the subject being underexposed.



[Beach] To record on a sunny beach without the subject being underexposed.



[Sunset] To record sunsets in vibrant colors.



[Low Light] To record in low-light situations.













[  **Spotlight** ] To record spotlight scenes.



[  **Fireworks** ] To record fireworks.



 NOTES

- [  Portrait ]/[  Sports ]/[  Snow ]/[  Beach ]: The picture may not appear smooth during playback.
- [  Portrait ]: The blur effect of the background increases the more you zoom in (  ).
- [  Snow ]/[  Beach ]: The subject may become overexposed on cloudy days or in shaded places. Check the image on the screen.
- [  Low Light ]:
  - Moving subjects may leave a trailing afterimage.
  - Picture quality may not be as good as in other modes.
  - White points may appear on the screen.
  - Autofocus may not work as well as in other modes. In such case, adjust the focus manually.
- [  Fireworks ]: To avoid camcorder blur (blur due to the camcorder moving) we recommend using a tripod.

## Looks and Other Image Effects

You have the option of adding a "look" to your recordings. A look is a combination of various picture settings that can enhance the recording's visual quality. You can also adjust various aspects of the picture, such as the color depth and sharpness.

Operating modes: CAMERA MEDIA | AVCHD MP4 | AUTO M CINEMA



### POINTS TO CHECK

- Select a recording program other than the Special Scene recording programs.

## Selecting a Look

If you do not plan to use a preset look, skip this procedure and perform the procedure *Adjusting Picture Settings* after this one.

### 1 Open the image effects screen.

[FUNC.] ➤ [Image Effects]

### 2 Touch [ON].

- Select [OFF] instead to turn off the image effects.

### 3 Touch [Looks] and then touch the desired option.

- To further adjust the picture, touch [↶] and continue with step 3 from the procedure below. If not, touch [✕].
- **ℒ** will appear on the screen. If you selected [Highlight Priority], **ℒ** will also appear on the screen.

### Options (♦ Default value)

**[Standard]♦** Standard look for general shooting situations.

**[Highlight Priority]** Creates a picture with a natural gradation in tones and reduces overexposure in bright areas by not compressing highlights.

**[Wide DR]** Applies a gamma curve with a very wide dynamic range and an appropriate color matrix.

## Adjusting Picture Settings

### 1 Open the image effects screen.

[FUNC.] ➤ [Image Effects]

### 2 Touch [ON].

- Select [OFF] instead to turn off the image effects.

### 3 Touch [Color Depth], [Sharpness], [Contrast] or [Brightness].



### 4 Touch [◀] or [▶] or drag your finger along the dial to adjust the effect level.

- + levels: richer colors, sharper image, stronger contrast, brighter image.
- levels: shallower colors, softer image, softer contrast, darker image.
- To adjust other parameters, touch [↶] to return to the image effects screen and repeat steps 3 and 4.

5 Touch [**X**] to save and apply the customized picture settings.

- **A** will appear on the screen. If you selected [Highlight Priority],  will also appear on the screen.

 NOTES

- Image effects are not available during infrared mode.
- When [FUNC.] ➤ [ Exposure] is set to [**M**], the [Brightness] parameter is not available.
- When the [FUNC.] ➤ [Image Effects] ➤ [Looks] setting is set to [Wide DR] or [Highlight Priority], the [Contrast] parameter is not available.
- When the [Looks] setting is set to [Highlight Priority], you can use the [FUNC.] ➤ [MENU] ➤  [ View Assistance] setting to display the picture on the screen with more accurate colors.
- When the [Looks] setting is set to [Wide DR], the lowest available gain setting is 6 dB. As such, when shooting outdoors in daylight or other bright surroundings, the subject may appear bright because the camcorder cannot achieve the optimal exposure.

## Setting the Time Code

The camcorder can generate a time code signal and embed it in your recordings. In addition, the time code will appear in the video output from the HD/SD-SDI terminal (**X415** only) and HDMI OUT terminal. You can select whether the time code is output from the HDMI OUT terminal (126). You can also select between a drop frame and non-drop frame time code.

Operating modes: **CAMERA** **MEDIA** | **AVCHD** **MP4** | **AUTO** **M** **CINEMA**

### Selecting the Running Mode

You can select the running mode of the camcorder's time code.

#### 1 Open the [Time Code Mode] screen.

[FUNC.] ➤ [MENU] ➤ [ ] ➤ [Time Code Mode]

#### 2 Touch the desired option.

- If you selected [**PRESET** Preset], touch [ ] and continue to step 3. If you selected [**REGEN.** Regen.], touch [**X**]; you do not need to perform the rest of this procedure.

#### 3 Touch [Time Code Running Mode].

- If you would like to set the time code's initial value, see the following section *Setting the Time Code's Initial Value*.

#### 4 Touch the desired option and then touch [**X**].

- If you selected [**FRERUN** Free Run], the time code will start running.

#### Options ( Default value)

**[PRESET Preset]** After you select this option, select a [Time Code Running Mode] option. With [**REC RUN** Rec Run], the time code runs only when recording and scenes on the same memory card will have a continuous time code; with [**FRERUN** Free Run], the time code runs regardless of the camcorder's operation. You can also choose to set the time code's initial value for either [Time Code Running Mode] option.

**[REGEN. Regen.]** The time code runs while recording. Use this running mode to continue from the last time code recorded on the memory card.

### Setting the Time Code's Initial Value

If you set the running mode to [**PRESET** Preset], you can set the initial value of the time code.

#### 1 Open the [Initial Time Code] screen.

[FUNC.] ➤ [MENU] ➤ [ ] ➤ [Initial Time Code]

- The time code setting screen will appear with the orange selection frame indicating the hours.
- To reset the time code to [00:00:00:00], select [Reset] instead.
- Touch [Cancel] to close the screen without setting the time code.

#### 2 Touch [**▲**] or [**▼**] to change the field as necessary.

#### 3 Touch another field you want to change (hours, minutes, seconds, frames).

#### 4 Change the rest of the fields in the same way.

#### 5 Touch [OK].

## Selecting Drop Frame or Non-Drop Frame

You can select between a drop frame (DF) or non-drop frame (NDF) time code, depending on how you plan to use your recording. When the frame rate is set to 23.98P, the time code will be set to non-drop frame.

1 Open the [DF/NDF] screen.

[FUNC.] ➤ [MENU] ➤  ➤ [DF/NDF]

70 2 Select [**DF** DF] or [**NDF** NDF] and then touch [**X**].

- The time code's display will differ depending on the setting. If you selected [**DF** DF], the time code will appear as [00:00:00.00]; if you select [**NDF** NDF], it will appear as [00:00:00:00].

### NOTES

- When the frame rate is set to 23.98P, the frames value in the time code runs from 0 to 23. For other settings, it runs from 0 to 29.
- When you are using pre-recording mode, [Free Run] is automatically set and cannot be changed.
- When you mix drop frame and non-drop frame time codes, there might be a discontinuity in the time code at the point where the recordings starts.
- As long as the built-in rechargeable lithium battery is charged and you selected the [Free Run] option, the time code continues to run even if you disconnect all other power sources. However, this is less accurate than when the camcorder is on.

## Setting the User Bit

The user bit display can be selected from the date or the time of recording, or an identification code consisting of 8 characters in the hexadecimal system. There are sixteen possible characters: the numbers 0 to 9 and the letters A to F. When you record a scene, the user bit will be recorded with it. The user bit is also output from the HD/SD-SDI terminal (**XA15** only) or HDMI OUT terminal.

Operating modes: **CAMERA** **MEDIA** | **AVCHD** **MP4** | **AUTO** **M** **CINEMA**

71

### 1 Open the user bit [Setting] screen.

[FUNC.] ➤ [MENU] ➤  ➤ [User Bit Type] ➤ **[SET]** Setting

- To set the time for the user bit, select **[TIME]** Time] instead; to set the date for the user bit, select **[DATE]** Date]. Then, touch **[X]**. The rest of the procedure is not necessary.
- The user bit setting screen will appear with the orange selection frame on the leftmost digit.
- To reset the user bit to [00 00 00 00], select [Reset].
- Touch [Cancel] to close the screen without setting the user bit.

### 2 Touch the digit you want to change and then touch [**▲**] or [**▼**] to change it as necessary.

### 3 Touch another digit you want to change.

### 4 Change the rest of the digits in the same way.

### 5 Touch [OK] and then touch **[X]**.

### NOTES

- When the frame rate is set to 23.98P and [FUNC.] ➤ [MENU] ➤  ➤ [User Bit Output Mode] is set to [Pulldown], the user bit will be 2:3 pulldown data.
- When playing back MP4 movies, the user bit embedded in the signal output from the HD/SD-SDI terminal (**XA15** only) and HDMI OUT terminal will have a value of 0 and cannot be changed.

## Recording Audio

You can record audio using the built-in stereo microphone, commercially available external microphone (INPUT 1/INPUT 2 terminals\*, MIC terminal) or line input (INPUT 1/INPUT 2 terminals\*). Using the INPUT 1/INPUT 2 terminals, you can select the audio input independently for channel 1 (CH1) and channel 2 (CH2).

\* Only available when the handle unit is attached to the camcorder.

When you are recording AVCHD movies and the recording mode is set to 28 Mbps LPCM or 24 Mbps LPCM, you can enjoy 2-channel, 16-bit linear PCM audio recording with a sampling frequency of 48 kHz. LPCM audio playback is also available for scenes recorded with those recording modes.

Operating modes: CAMERA MEDIA | AVCHD MP4 | AUTO M CINEMA

### Audio Settings and Recorded Audio Channels

The available audio recording options depend on whether the handle unit is attached to the camcorder, the position of the INPUT terminal ON/OFF switch, and whether an audio source is connected to the MIC terminal.

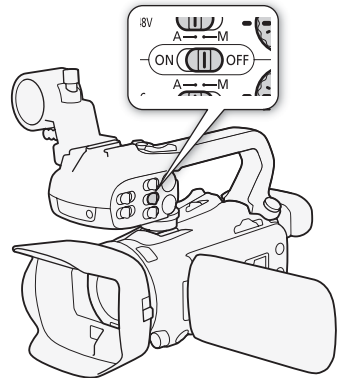

Handle unit	INPUT terminal ON/OFF switch position	Audio source connected to the MIC terminal	[CH2 Input] <sup>1</sup>	Recorded audio channels/audio sources	
				CH1	CH2
Attached	ON	–	[ INPUT2 INPUT 2 ] [ INPUT1 INPUT 1 ]	INPUT 1 terminal	INPUT 2 terminal
		Yes	[ INT/MIC Built-in Mic/MIC ]		INPUT 1 terminal
		No			
Attached	OFF	Yes	–	MIC terminal (L)	MIC terminal (R)
Not attached	–				
Attached	OFF	No	–	Built-in microphone (L)	Built-in Microphone (R)
Not attached	–				

<sup>1</sup> [FUNC.] ➤ [MENU] ➤ [ ] ➤ [CH2 Input] setting.

<sup>2</sup> Monaural audio.



## Connecting an External Microphone or External Audio Input Source to the Camcorder

In order to use the microphone holder and INPUT 1/INPUT 2 terminals, the handle unit must be attached to the camcorder.

- 1 Loosen the microphone lock screw (①), open the microphone holder and insert the microphone (②).
- 2 Tighten the lock screw and put the microphone cable through the microphone cable clamp under the microphone holder (③).
- 3 Plug the microphone or external device's cable into the desired INPUT terminal (④) or the MIC terminal (⑤).

73

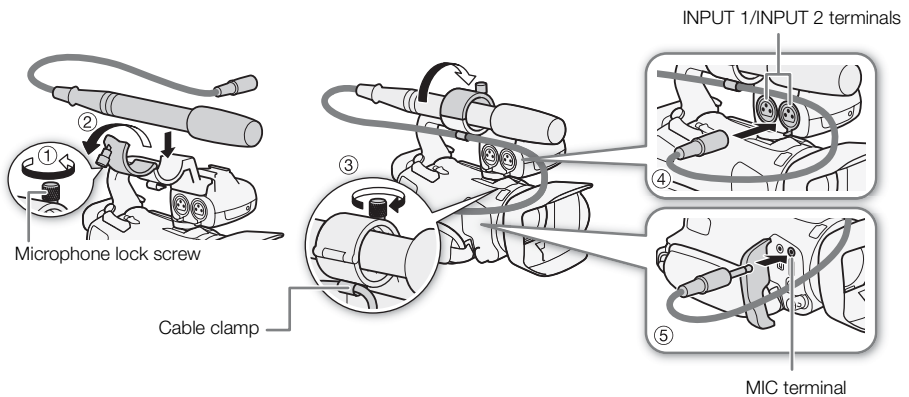

## Using Line Input or an External Microphone Connected to an INPUT Terminal

- 1 Set the INPUT terminal ON/OFF switch to ON.
- 2 Set the input selection switches for INPUT 1/INPUT 2 to LINE or MIC.
  - To supply a microphone with phantom power, set the switch to MIC+48V instead. Make sure to connect the microphone first, before turning the phantom power on. Keep the microphone connected when turning off the phantom power.

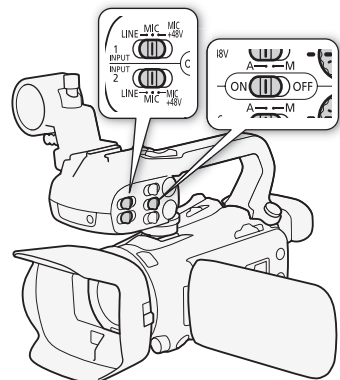

## Recording Audio to Channel 2 (CH2)

You can select the audio source that will be recorded to channel 2.

### 1 Open the [CH2 Input] screen.

[FUNC.] ➤ [MENU] ➤ [CAMERA] ➤ [CH2 Input]

### 2 Touch the desired option and then touch [X].

#### Options (\* Default value)

**[INPUT1] INPUT 1** The audio signal input through the INPUT 1 terminal will be recorded to channel 1 and channel 2. You can use this setting when recording audio for backup purposes.

**[INPUT2] INPUT 2**\* The audio signal input through the INPUT 2 terminal will be recorded to channel 2 while the audio signal input through the INPUT 1 terminal will be recorded to channel 1.

**[INT/MIC] Built-in Mic/MIC** The audio captured by the built-in microphone or audio signal input through the MIC terminal will be recorded to channel 2 while the audio signal input through the INPUT 1 terminal will be recorded to channel 1. You can use this setting when recording audio for backup purposes.

#### NOTES

- Even if you select **[INPUT1] INPUT 1**, the audio recording level for channel 2 will be determined by the audio level switch and dial for INPUT 2.
- If you select **[INT/MIC] Built-in Mic/MIC**, the camcorder will record monaural sound. In such case, [FUNC.] ➤ **[AUDIO] Audio Scene** will be set to **[STD] Standard**.

## Audio Recording Level (INPUT Terminals)

You can set the audio recording level for audio input to automatic or manual independently for each channel. Furthermore, when you adjust the audio recording level manually, you can set the level (from  $-\infty$  to 18 dB) independently for each channel, as well.

### 1 Set the audio level switch of the desired channel to A (automatic) or M (manual).



- If you set the switch to A, the audio level will be adjusted automatically and you do not need to perform the rest of the procedure. If you set the switch to M, continue the procedure to set the audio recording level.

### 2 Turn the corresponding audio level dial.

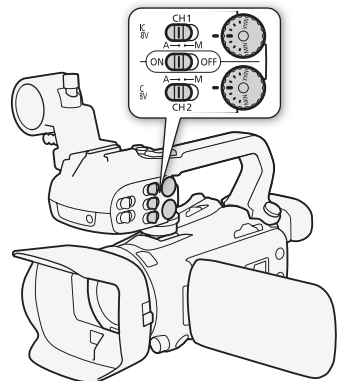
- For reference, MIN corresponds to  $-\infty$ , the larger mark in the middle of the scale corresponds to 0 dB, and MAX corresponds to +18 dB.
- As a guideline, adjust the audio recording level so that the audio level meter will go to the right of the  $-18$  dB mark (one mark right of the  $-20$  dB mark) only occasionally.



## NOTES

- When the audio level meter reaches the red point (0 dB), the sound may be distorted.
- If the audio level meter display is normal but the sound is distorted, activate the microphone's attenuator (🔊 75).
- We recommend using headphones to check the sound level while adjusting the audio recording level or when the microphone attenuator is activated.
- When using automatic adjustment, if both INPUT 1 and INPUT 2 are set to the same audio input (external microphone or external line input), you can use the [FUNC.] ➤ [MENU] ➤  ➤ [INPUT 1/2 ALC Link] setting to link the audio level adjustment of both channels.
- If at least one of the channels is set to manual adjustment, you can activate the audio peak limiter with the [FUNC.] ➤ [MENU] ➤  ➤ [INPUT 1/2 Limiter] setting. When activated, **LIMIT** appears on the screen and the audio peak limiter will limit the amplitude of audio input signals so that they do not exceed -6 dBFS.

## Adjusting the Microphone's Sensitivity (INPUT terminals)

You can adjust the sensitivity of a microphone connected to the INPUT 1 or INPUT 2 terminal.



### POINTS TO CHECK

- Set the input selection switch of the desired INPUT terminal to MIC or MIC+48V.
- 1 Open the desired INPUT terminal's sensitivity submenu.  
[FUNC.] ➤ [MENU] ➤  ➤ [INPUT 1 Mic Trimming] or [INPUT 2 Mic Trimming]
  - 2 Touch the desired level and then touch [X].
    - The available sensitivity levels are +12 dB, +6 dB, 0 dB, -6 dB and -12 dB.

## Activating the Microphone's Attenuator (INPUT terminals)

You can activate the microphone attenuator (20 dB) for microphones connected to the INPUT 1 and INPUT 2 terminals to prevent audio from being distorted if the audio level is too high.



### POINTS TO CHECK

- Set the input selection switch of the desired INPUT terminal to MIC or MIC+48V.
- 1 Open the desired INPUT terminal's microphone attenuator submenu.  
[FUNC.] ➤ [MENU] ➤  ➤ [INPUT 1 Mic Att.] or [INPUT 2 Mic Att.]
  - 2 Touch **[ON]** On] and then touch [X].

## Using the Built-in Microphone or an External Microphone Connected to the MIC Terminal

Follow the step below to use the built-in microphone or an external microphone connected to the MIC terminal. Use commercially available condenser microphones with their own power supply and a  $\varnothing$  3.5 mm mini-stereo plug.

Set the INPUT terminal ON/OFF switch to OFF.

- If you connect a microphone to the MIC terminal while the INPUT terminal ON/OFF switch is set to OFF, the camcorder will switch automatically from the built-in microphone to the external microphone.

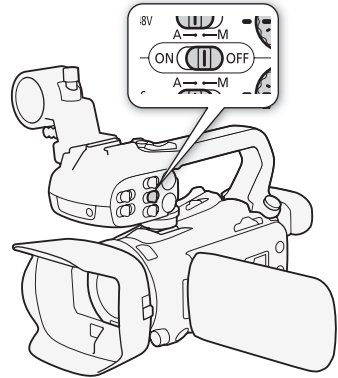

### Switching the Input (MIC Terminal)

You can switch the input of the MIC terminal depending on whether you are using an external microphone or an external audio source, such as a digital audio player.

Operating modes: CAMERA MEDIA | AVCHD MP4 | AUTO M CINEMA

1 Open the [MIC Terminal Input] screen.

[FUNC.] ➤ [MENU] ➤ [MIC Terminal Input]

2 Touch [LINE External Audio] or [MIC Microphone] and then touch [X].

### Audio Scenes

You can have the camcorder optimize the audio settings of the built-in microphone by selecting the audio scene that matches your surroundings. This will greatly enhance the sense of "being there". Alternatively, you can select [♪ Custom Setting]\* in order to adjust the camcorder's various audio settings to your liking.

See the following table for the settings used by each audio scene.

\* Not available in [AUTO] mode.

Operating modes: CAMERA MEDIA | AVCHD MP4 | AUTO M CINEMA

1 Open the audio scene selection screen.

[FUNC.] ➤ [AUDIO Audio Scene]

2 Touch the desired option and then touch [X].

- When you select [♪ Custom Setting], customize the audio settings to your preference with the relevant procedures (see the reference pages in the following table).

**Options** (♦ Default value)

[**STD** Standard] To record most general situations. The camcorder records with standard settings.

[**MUSIC** Music] To vibrantly record music performances and singing indoors.

[**PEOPLE** Speech] Best for recording human voices and dialog.

[**BIRDS** Forest and Birds] To record birds and scenes in forests. The camcorder clearly captures sound as it spreads.

[**NOISE** Noise Suppression] To record scenes while reducing noise from wind, passing vehicles and similar ambient sound. Ideal for recording at the beach or in places with a lot of noise.

[**CUSTOM** Custom Setting]♦ Allows you to adjust the audio settings to your liking. The settings that you can adjust are the [**MIC** Mic Level] setting in the FUNC. menu and the following settings in the [MENU] menu: [Built-in Mic Wind Screen], [Built-in Mic Att.], [Built-in Mic Freq. Response] (audio equalizer), and [Built-in Mic Directionality].

**Settings for each audio scene**

	[ <b>MIC</b> Mic Level]	[Built-in Mic Att.]	[Built-in Mic Wind Screen]	[Built-in Mic Freq. Response]	[Built-in Mic Directionality]
[ <b>STD</b> Standard]	[ <b>M</b> ] (manual): 70	[ <b>A</b> ] Automatic	[ <b>H</b> Auto (High)]	[ <b>NORM</b> Normal]	[ <b>NORM</b> Normal]
[ <b>MUSIC</b> Music]	[ <b>M</b> ] (manual): 70	[ <b>A</b> ] Automatic	[ <b>L</b> Auto (Low)	[ <b>LHB</b> Boost HF+LF Range]	[ <b>WIDE</b> Wide]
[ <b>PEOPLE</b> Speech]	[ <b>M</b> ] (manual): 86	[ <b>A</b> ] Automatic	[ <b>H</b> Auto (High)]	[ <b>MB</b> Boost MF Range]	[ <b>MONO</b> Monaural]
[ <b>BIRDS</b> Forest and Birds]	[ <b>M</b> ] (manual): 80	[ <b>A</b> ] Automatic	[ <b>H</b> Auto (High)]	[ <b>LC</b> Low Cut Filter]	[ <b>WIDE</b> Wide]
[ <b>NOISE</b> Noise Suppression]	[ <b>M</b> ] (manual): 70	[ <b>A</b> ] Automatic	[ <b>H</b> Auto (High)]	[ <b>LC</b> Low Cut Filter]	[ <b>MONO</b> Monaural]
[ <b>CUSTOM</b> Custom Setting]	Selected by user				
	( 77 )	( 80 )	( 79 )	( 79 )	( 78 )

**NOTES**

- [**CUSTOM** Custom Setting] is not available in **AUTO** mode. After setting [**AUDIO** Audio Scene] to [**CUSTOM** Custom Setting], if the camcorder is then set to **AUTO** mode, this setting will change to [**STD** Standard].

**Audio Recording Level (Built-in Microphone/MIC Terminal)**

You can adjust the audio recording level of the built-in microphone or an external microphone connected to the MIC terminal. You can display the audio level indicator while recording.

Operating modes: **CAMERA** **MEDIA** | **AVCHD** **MP4** | **AUTO** **M** **CINEMA**

1 When setting the audio recording level of the built-in microphone, set [**AUDIO** Audio Scene] to [**CUSTOM** Custom Setting] ( 76 ).

2 Open the manual audio recording level adjustment screen.

[FUNC.] ➤ [**MIC** Mic Level] ➤ [**M**] (manual)

- The audio level indicator and current audio recording level will appear on the screen.
- Touch [**A**] (automatic) to return the camcorder to automatic audio recording levels.

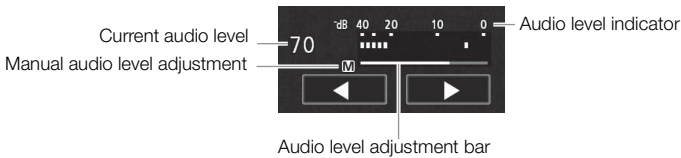

3 Touch and hold [◀] or [▶] to adjust the audio recording level as necessary.

- As a guideline, adjust the audio recording level so that the audio level meter will go to the right of the -18 dB mark (one mark right of the -20 dB mark) only occasionally.

4 Touch [X] to lock the audio recording level at the current level.

To display the audio level indicator

Usually, the audio level indicator will be displayed only after activating the manual adjustment of the audio recording level. You can choose to display it also when the audio level is adjusted automatically.

1 Open the automatic audio recording level screen.

[FUNC.] ➤ [🔇 Mic Level] ➤ [A] (automatic)

2 Touch [Audio Level Indicator] and then touch [X].

**i** NOTES

- When the audio level meter reaches the red point (0 dB), the sound may be distorted.
- We recommend using headphones to check the sound level while adjusting the audio recording level or when the microphone attenuator is activated.

Microphone Directionality (Built-in Microphone)

You can change the directionality of the built-in microphone to have more control over how sound is recorded.

Operating modes: CAMERA MEDIA | AVCHD MP4 | AUTO M CINEMA

1 Set [AUDIO Audio Scene] to [🎵 Custom Setting] (📖 76).

2 Open the [Built-in Mic Directionality] screen.

[FUNC.] ➤ [MENU] ➤ [🎙️] ➤ [Built-in Mic Directionality]

3 Touch the desired option and then touch [X].

Options (\* Default value)

[**2ch** MONO] **Monaural** Mono recording that emphasizes sound coming from the front of the camcorder/microphone.

[**NORM**] **Normal**\* Standard stereo recording; a middle point between the [**2ch** WIDE] Wide and [**2ch** MONO] Monaural] settings in reach.

[**2ch** WIDE] **Wide** Stereo recording of ambient sound over a more extensive area that adds to the sense of presence of movies.

[**2ch** ZOOM] **Zoom** Stereo recording with the sound linked to the zoom position. The larger the subject appears on the screen, the louder the sound will be.

## Audio Equalizer (Built-in Microphone)

You can use the audio equalizer to adjust sound levels by specifically targeting the high- or low-frequency range and selecting one of 3 available levels.

Operating modes: **CAMERA** **MEDIA** | **AVCHD** **MP4** | **AUTO** **M** **CINEMA**

- 1 Set **[AUDIO Audio Scene]** to **[♪ Custom Setting]** (📖 76).
- 2 Open the **[Built-in Mic Freq. Response]** screen.  
**[FUNC.]** ➤ **[MENU]** ➤ **[🔊]** ➤ **[Built-in Mic Freq. Response]**
- 3 Touch the desired option and then touch **[X]**.

### Options (⬆ Default value)

**[NORM Normal]⬆** Appropriate for balanced sound under most normal recording conditions.

**[LB Boost LF Range]** Accentuates the low-frequency range for more powerful sound.

**[LC Low Cut Filter]** Filters the low-frequency range to reduce the noise of blowing wind, a car's engine and similar ambient sounds.

**[MB Boost MF Range]** Best for recording human voices and dialog.

**[LHB Boost HF+LF Range]** Best, for example, for recording live music and clearly capture the special sound characteristics of a variety of instruments.

## Wind Screen (Built-in Microphone)

The camcorder automatically reduces the background sound of wind when recording outdoors. You can select from two levels or turn off the auto wind screen.

Operating modes: **CAMERA** **MEDIA** | **AVCHD** **MP4** | **AUTO** **M** **CINEMA**

- 1 Set **[AUDIO Audio Scene]** to **[♪ Custom Setting]** (📖 76).
- 2 Open the **[Built-in Mic Wind Screen]** screen.  
**[FUNC.]** ➤ **[MENU]** ➤ **[🔊]** ➤ **[Built-in Mic Wind Screen]**
- 3 Touch the desired option and then touch **[X]**.

### Options (⬆ Default value)

**[H Auto (High)]⬆** The camcorder will automatically activate the built-in microphone wind screen at a high level, as necessary.

**[L Auto (Low) 🗙🗚]** The camcorder will automatically activate the built-in microphone wind screen at a low level, as necessary.

**[OFF Off 🗙🗚]** The built-in microphone wind screen will be deactivated at all times.

### NOTES

- Some low-frequency sounds will be suppressed along with the sound of wind. When recording in surroundings unaffected by wind or if you want to record low-frequency sounds, we recommend setting **[Built-in Mic Wind Screen]** to **[OFF Off 🗙🗚]**.

## Microphone Attenuator (Built-in Microphone)

If the audio level is too high and the audio sounds distorted while recording with the built-in microphone, activate the microphone attenuator (20 dB).

Operating modes: **CAMERA** **MEDIA** | **AVCHD** **MP4** | **AUTO** **M** **CINEMA**

1 Set [**AUDIO** Audio Scene] to [**Custom Setting**] (76).

2 Open the [**Built-in Mic Att.**] screen.

[FUNC.] ➤ [MENU] ➤ [MIC] ➤ [Built-in Mic Att.]

3 Touch the desired option and then touch [**X**].

### Options (\* Default value)

**[A Automatic]**\* The camcorder will automatically activate the built-in microphone attenuator as necessary for optimal audio recording levels so high audio levels will not be distorted.

**[ON On]** The built-in microphone attenuator will be activated at all times to reproduce more faithfully the sound dynamics. **ATT** will appear on the screen.

**[OFF Off]** The built-in microphone attenuator will be deactivated at all times. **AOff** will appear on the screen.

## Low Cut Filter (MIC Terminal)

When you are recording using a microphone connected to the MIC terminal, you can activate the low cut filter to reduce the sound of blowing wind, a car's engine and similar ambient sounds.

Operating modes: **CAMERA** **MEDIA** | **AVCHD** **MP4** | **AUTO** **M** **CINEMA**

1 Open the [**MIC Low Cut**] screen.

[FUNC.] ➤ [MENU] ➤ [MIC] ➤ [MIC Low Cut]

2 Touch [**ON On**] and then touch [**X**].

### NOTES

- When recording in surroundings unaffected by wind or if you want to record low-frequency sounds, we recommend setting [MIC Low Cut] to [**OFF Off**].



## Microphone Attenuator (MIC Terminal)

You can activate the microphone attenuator (20 dB) for a microphone connected to the MIC terminal to prevent audio from being distorted if the audio level is too high.

Operating modes: **CAMERA** **MEDIA** | **AVCHD** **MP4** | **AUTO** **M** **CINEMA**

1 Open the [MIC Att.] screen.

[FUNC.] ➤ [MENU] ➤  ➤ [MIC Att.]

2 Touch the desired option and then touch [X].

### Options (♦ Default value)

**[A Automatic]♦** The camcorder will automatically activate the microphone attenuator as necessary for optimal audio recording levels so high audio levels will not be distorted.

**[On On]** The microphone attenuator will be activated at all times to reproduce more faithfully the sound dynamics. **ATT** will appear on the screen.

**[Off Off]** The microphone attenuator will be deactivated at all times. **AOff** will appear on the screen.

## Using Headphones

Use headphones for playback or to check the audio level while recording. The following procedure explains how to adjust the volume.

Operating modes: CAMERA MEDIA | AVCHD MP4 | AUTO M CINEMA

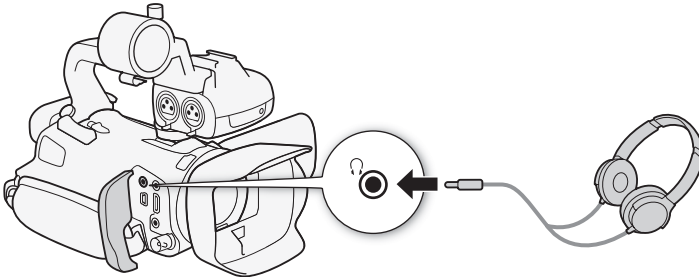

1 Connect headphones to the (headphone) terminal.

2 Open the [Headphone Volume] screen.

[FUNC.] ➤ [MENU] ➤ ➤ [Headphone Volume]

- Touching [FUNC.] is necessary only when performing the procedure in CAMERA mode.

3 Touch [] or [] to adjust the volume and then touch [].

- You can also drag your finger along the volume bar.

### To adjust the volume during playback

During playback, adjust the headphones volume the same way you adjust the speaker's volume ( 95).

#### IMPORTANT

- When using headphones, make sure to lower the volume to an appropriate level.

#### NOTES

- Use commercially available headphones with a  $\varnothing$  3.5 mm minijack.
- When you are monitoring the audio, you can choose to synchronize the audio signal with the video signal or monitor the audio in real time. Use the [FUNC.] ➤ [MENU] ➤ ➤ [Monitor Delay] setting to select the method. Note that there will be a slight delay when you monitor in real time. Regardless of the setting, however, the audio and video signals recorded will be synchronized.

## Color Bars/Audio Reference Signal

You can have the camcorder output and record color bars and a 1 kHz audio reference signal and output them from the HDMI OUT terminal, AV OUT terminal, HD/SD-SDI terminal (**XA15** only) and  $\Omega$  (headphone) terminal (audio reference signal only).

Operating modes: **CAMERA** **MEDIA** | **AVCHD** **MP4** | **AUTO** **M** **CINEMA**

### Recording Color Bars

You can choose between SMPTE standard-definition color bars and ARIB multi-format HDTV color bars.

#### 1 Open the [Color Bars] menu.

[FUNC.]  $\blacktriangleright$  [MENU]  $\blacktriangleright$    $\blacktriangleright$  [Color Bars]

#### 2 Touch the desired option and then touch [X].

- The selected color bars appear on the screen and will be recorded when you press the START/STOP button.

### Recording an Audio Reference Signal

The camcorder can output a 1 kHz audio reference signal with the color bars.

#### 1 Open the [1 kHz Tone] submenu.

[FUNC.]  $\blacktriangleright$  [MENU]  $\blacktriangleright$    $\blacktriangleright$  [1 kHz Tone]

#### 2 Select the desired level and then touch [X].

- Available levels are -12 dB, -18 dB and -20 dB.
- Select [**OFF** Off] to turn off the signal.
- The signal is output at the selected level and will be recorded when you press the START/STOP button.

## Video Snapshot

Record a series of short scenes. To record a video snapshot scene, set an assignable button to [Video Snapshot] in advance.

Operating modes: CAMERA MEDIA | AVCHD MP4 | AUTO M CINEMA

1 Set an assignable button to [Video Snapshot] (91).

2 Press the assignable button to activate video snapshot mode.

- 4sec (the default length of a video snapshot scene) appears on the screen.
- Press the button again to deactivate video snapshot mode.

3 Press the START/STOP button.

- The camcorder records for a few seconds and then automatically returns to record standby mode.
- When the camcorder stops recording, the screen will momentarily turn black as if a camera shutter had released.

### NOTES

- The default length of a video snapshot scene is 4 seconds but you can change it to 2 or 8 seconds with the [FUNC.] > [MENU] > [Video Snapshot Length] setting.
- Any of the following will deactivate video snapshot mode:
  - Turning off the camcorder.
  - Changing the camcorder's operating mode.
  - Changing the movie format or frame rate.

## Pre-Recording

The camcorder will start recording 3 seconds before you press the START/STOP button, ensuring you do not miss important shooting opportunities. This is especially useful when it is difficult to predict when to start recording.

By default, the pre-recording function is assigned to assignable button 2.

Operating modes: **CAMERA** **MEDIA** | **AVCHD** **MP4** | **AUTO** **M** **CINEMA**

### 1 Press the PRE REC button.



-  will appear on the screen.
- Press the PRE REC button again to turn off pre-recording.

### 2 Press the START/STOP button.

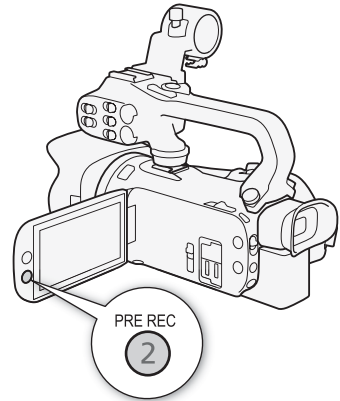
- The scene recorded on the memory card will start 3 seconds before the START/STOP button was pressed.



### NOTES

- The camcorder will not record the full 3 seconds prior to pressing the START/STOP button if the button was pressed within 3 seconds of having turned on pre-recording or having finished the previous recording.
- Any of the following actions will deactivate the pre-recording function.
  - Leaving the camcorder without any operation for 1 hour.
  - Changing the camcorder's operating mode.
  - Activating video snapshot.
  - Touching any of the following onscreen buttons in the FUNC. menu: [MENU], [Rec. Programs], [WB White Balance], [AGC AGC Limit], [AUDIO Audio Scene] or [Image Stabilizer].
  - Changing the [FUNC.]  [Image Effects]  [Looks] setting.

## Onscreen Displays and Data Code

You can turn most onscreen displays on or off.

Operating modes: **CAMERA** **MEDIA** | **AVCHD** **MP4** | **AUTO** **M** **CINEMA**

Repeatedly press the DISP. button to turn the onscreen displays on/off in the following sequence:

**CAMERA** mode:

- All displays on
- Onscreen markers<sup>1</sup>
- Displays off

**MEDIA** mode<sup>2</sup>:

- Only data code on
- All displays on

<sup>1</sup> The onscreen markers will be displayed only when [FUNC.] ➤ [MENU] ➤ [Onscreen Markers] is set to an option other than [Off].

<sup>2</sup> Pressing [DISP.] has the same effect as touching the screen. During single photo view and while playing back a scene, the playback controls are displayed only momentarily.

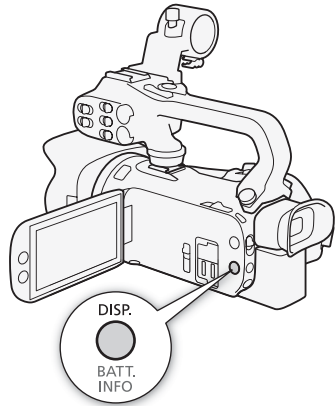

### About the Data Code

With every scene or photo recorded, the camcorder keeps a data code (date/time of recording, information about the camera setup, etc.).

You can select the information to be displayed with the [MENU] ➤ [Data Code] setting. Note that available options depend on the type of recording.

## Infrared Recording

Using the infrared mode, the camcorder becomes more sensitive to infrared light, allowing you to record in dark locations. You can also use the handle unit's infrared light to keep shooting even in very dark conditions. Also, you can select whether the brighter areas of the picture appear in green or white.

Operating modes: **CAMERA** **MEDIA** | **AVCHD** **MP4** | **AUTO** **M** **CINEMA**

### Activating Infrared Mode

Follow the procedure below to set the camcorder to infrared (IR) mode and to set the color of highlights in the picture.

Set the INFRARED switch to ON.



- **IR** and **OFF** appear on the screen.

To select a color for infrared recording

- 1 Open the [IR Rec Color] screen to select a color.  
[FUNC.] ➤ [MENU] ➤  ➤ [IR Rec Color]
- 2 Touch [**WHITE** White] or [**GREEN** Green] and then touch [**X**].

To use the infrared light

The handle unit must be attached to use the infrared light.

- 1 Open the [IR Light] screen.  
[FUNC.] ➤ [MENU] ➤  ➤ [IR Light]
- 2 Touch [**ON** On] and then touch [**X**].
  - Alternatively, you can set an assignable button to [**IR Light**] ( 91).
  - **OFF** changes to **ON**.

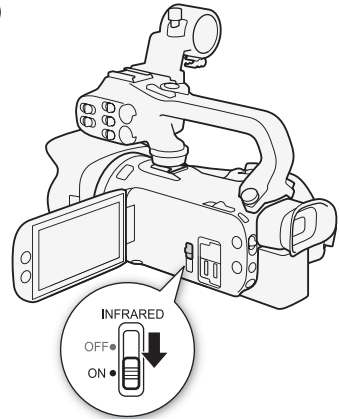

### NOTES

- When the camcorder is in infrared mode, the following adjustments are made automatically.
  - Gain, shutter speed and aperture are set to automatic levels.
  - Autofocus is activated. However, you can change the focus mode to manual focus.
  - AGC limit, white balance, image effects, exposure, backlight correction, recording program and face detection & tracking cannot be set. Also, [**LAF** Instant AF] and [**MAF** Medium AF] cannot be set for the AF mode.
  - ND filters are not available.
- Depending on the light source, autofocus may not work well while zooming.
- When switching the camcorder to infrared mode, do not point the lens at strong sources of light or heat. The camcorder's sensitivity to such sources is much higher than when shooting video normally. If there are such sources in the picture before you switch the camcorder to infrared mode, shield the lens first.

## Using the GP-E2 GPS Receiver

When you attach the optional GP-E2 GPS Receiver to the camcorder, you can acquire GPS information (latitude, longitude and altitude) and add it to your movies and photos.

### Connecting the GPS Receiver

Turn off the camcorder and the receiver. Connect the receiver to the camcorder's USB terminal using the USB cable\*. While recording, place the receiver in the carrying case\* and attach it to the camcorder's grip belt or carry it on your person. For details about connecting and using the receiver, refer to the GP-E2 Instruction Manual.

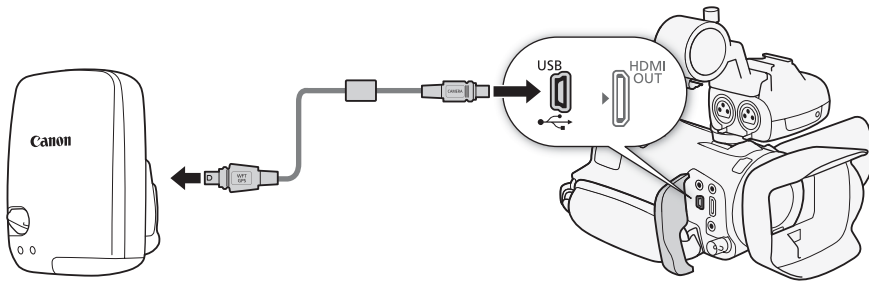

\* Supplied with the optional GP-E2 GPS Receiver.



### Activating the GPS Receiver

Operating modes: **CAMERA** **MEDIA** | **AVCHD** **MP4** | **AUTO** **M** **CINEMA**

Turn on the camcorder and receiver.



- The  icon appears on the right of the screen and will blink as the receiver tries to acquire satellite signals.
- When satellite signals are correctly acquired, the  icon will stay continuously on. GPS functions will be activated, and scenes and photos recorded thereafter will be geotagged.

#### IMPORTANT

- In certain countries/regions, the use of GPS may be restricted. Be sure to use the GPS receiver in accordance with local laws and regulations of the country/region where the receiver is used. Be particularly careful when traveling outside of your home country.
- Be careful about using the GPS receiver in places where the use of electronic devices is restricted.
- The GPS information recorded with scenes and photos may contain data that can lead others to locate or identify you. Be careful when sharing geotagged recordings with others or when uploading them to the Web.
- Do not leave the GPS receiver near strong electromagnetic fields such as near powerful magnets and motors.



 NOTES

- GPS signal reception may take some time after replacing the battery pack or when first turning on the camcorder after a long period without use.
- The camcorder is not compatible with the GPS receiver's digital compass and positioning interval functions. Also, the [Set now] option is not available for [FUNC.] ➤ [MENU] ➤   ➤ [GPS Auto Time Setting].
- You cannot add GPS information to the following types of recordings.
  - Photos captured from a movie.
  - MP4 movies that were converted from another movie.
- GPS information added to AVCHD movies cannot be deleted with the camcorder or software Data Import Utility.

# 4 Customization

## CUSTOM Dial and Button

You can assign to the CUSTOM button and the CUSTOM dial one of several frequently used functions. You can then adjust the selected function using the CUSTOM button and the CUSTOM dial, without having to access the menu.

Operating modes: **CAMERA** **MEDIA** | **AVCHD** **MP4** | **AUTO** **M** **CINEMA**

1 Press and hold the CUSTOM button for approx. 1 second.

- A quick menu of available options will appear.

2 Turn the CUSTOM dial to select the desired option and then press the CUSTOM button.

- Alternatively, you can select an option using the [FUNC.]  
➤ [MENU] ➤  ➤ [CUSTOM Dial & Button] setting.

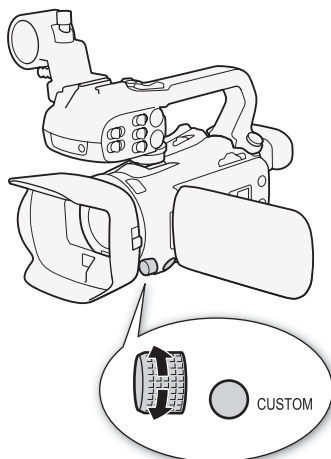

### Options (♦ Default value)

**[Tv/Av Tv/Av]** When you set the recording program to [**Tv** Shutter-Pri. AE] or [**Av** Aperture-Pri. AE], you can adjust the shutter speed or aperture value with the CUSTOM dial.

**[M Manual Exposure]** When you set the recording program to [**M** Manual Exposure], repeatedly press the CUSTOM button to toggle between the aperture value, shutter speed and gain. Next, use the CUSTOM dial to adjust the setting.

**[AGC AGC Limit]** Adjusts the AGC limit. Press the CUSTOM button to switch the AGC limit to manual adjustment and then use the CUSTOM dial to adjust it. Press the button again to switch it back to automatic.

**[Exposure]♦** When using a recording program other than [**Fireworks**] or [**M** Manual Exposure], you can compensate the automatic exposure set by the camcorder. Press the CUSTOM button to switch the exposure compensation to manual adjustment and then use the CUSTOM dial to adjust it. Press the button again to switch it back to automatic.

**[OFF Off]** Use this setting if you do not intend to use the CUSTOM button or the CUSTOM dial.

## Assignable Buttons

The camcorder conveniently features 5 buttons to which you can assign various functions. By assigning often used functions, you can quickly access them with a single press of a button.

Operating modes: **CAMERA** **MEDIA** | **AVCHD** **MP4** | **AUTO** **M** **CINEMA**

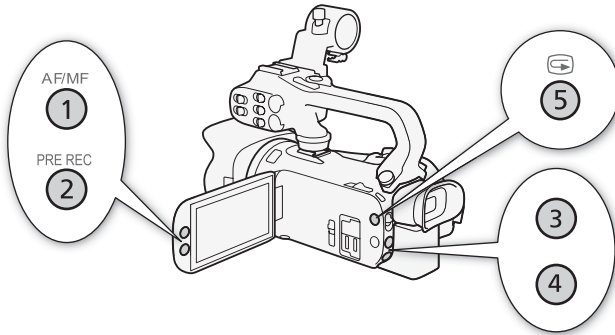

## Changing the Assigned Function

1 Open the selection screen for the desired assignable button.

[FUNC.] ➤ [MENU] ➤ [ ] ➤ Select from [Assign Button 1] to [Assign Button 5]

2 Select the desired option and then touch [X].

### Options

[ ] **Powered IS**\* Turns Powered IS on/off ( 56).

[\*] **BLC Always On**\* Turns backlight correction on/off ( 62).

[ ] **Face Only AF**\* Turns face only autofocus on/off ( 51).

[ ] **Video Snapshot** Turns video snapshot on/off ( 84).

[ ] **WB WB Priority**\* Turns white balance priority on/off ( 125).

[ ] **Pre REC** Turns pre-recording on/off ( 85). Default setting for assignable button 2.

[ ] **IR Light**\*\* Turns the infrared light on/off ( 87).

[CH/CH] **Audio Output CH**\*\* Switches the audio output channel between CH1/CH2, CH1/CH1, CH2/CH2 and All/All ( 105).

[AF/MF] **AF/MF**\* Switches between autofocus and manual focus ( 47). Default setting for assignable button 1.

[ ] **Rec Review** Reviews the last scene that was recorded ( 39). Default setting for assignable button 5.

[FUNC.] **Rec. Programs**\* Functions the same as selecting [Rec. Programs] ( 58, 60, 65) in the FUNC. menu.

[FUNC.] **BLC Always On**\* Functions the same as selecting [\*] **BLC Always On** ( 62) in the FUNC. menu.

[FUNC.] **White Balance**\* Functions the same as selecting [WB White Balance] ( 63) in the FUNC. menu.

**[FUNC. AGC Limit]\*** Functions the same as selecting **[AGC AGC Limit]** (📖 57) in the FUNC. menu.

**[FUNC. Focus]\*** Functions the same as selecting **[👁 Focus]** (📖 47) in the FUNC. menu.

**[FUNC. Exposure]\*** Functions the same as selecting **[📷 Exposure]** (📖 60) in the FUNC. menu.

**[FUNC. Audio Scene]** Functions the same as selecting **[AUDIO Audio Scene]** (📖 76) in the FUNC. menu.

**[FUNC. Mic Level]\*** Functions the same as selecting **[🗣 Mic Level]** (📖 77) in the FUNC. menu.

**[FUNC. Zoom]** Functions the same as selecting **[ZOOM Zoom]** (📖 52) in the FUNC. menu.

**[FUNC. Image Stabilizer]\*** Functions the same as selecting **[Image Stabilizer]** (📖 56) in the FUNC. menu.

**[FUNC. Image Effects]\*** Functions the same as selecting **[Image Effects]** (📖 67) in the FUNC. menu.

**[OFF Off]** Does not assign a function to the assignable button. Default setting for assignable button 3 and assignable button 4.

\* Even if this function is assigned to an assignable button in **[M]** or **[CINEMA]** mode, the button will be disabled if you set the camcorder to **[AUTO]** mode.

\*\* Requires attaching the handle unit in advance.

## Using an Assignable Button

After you assign a function to one of the buttons, press the button to activate the function.



## Saving and Loading Menu Settings

After you adjust the cinema-look filters and other settings in the FUNC. menu and setup menus, you can save those settings on memory card B. You can load those settings at a later date or on another XA15 or XA11 camcorder so that you can use that camcorder in the same way.



Operating modes:   |   |   

### Saving Menu Settings to a Memory Card

Menu settings must be saved to memory card B. If the memory card already has menu settings on it, they will be overwritten.

- 1 Insert a memory card into memory card slot **B**.
- 2 Open the [Backup Menu Settings **B**] screen.  
[FUNC.] ➤ [MENU] ➤   ➤ [Backup Menu Settings **B**]
- 3 Touch [Save] and then touch [Yes].
  - The current settings are saved to the memory card.
- 4 Touch [OK] and then touch [**X**].

### Loading Menu Settings from a Memory Card

- 1 Insert a memory card with menu settings into memory card slot **B**.
- 2 Open the [Backup Menu Settings **B**] screen.  
[FUNC.] ➤ [MENU] ➤   ➤ [Backup Menu Settings **B**]
- 3 Touch [Load] and then touch [Yes].
  - After the camcorder's current settings are replaced with the settings saved on the memory card, the screen will turn black momentarily and the camcorder will restart.

#### NOTES

- The camcorder can load settings from other XA15 and XA11 camcorders. After settings are loaded, settings common to both camcorders are overwritten while settings not common to both are returned to default values.

# 5 Playback

## Playing Back Video

This section explains how to play back scenes. For details on playing back scenes using an external monitor, refer to *Connecting to an External Monitor* (□ 102).

94

Operating modes: **CAMERA** **MEDIA** | **AVCHD** **MP4** | **AUTO** **M** **CINEMA**

### 1 Set the power switch to MEDIA.

- The AVCHD or MP4 movie index screen will appear.

### 2 If necessary, change the index screen.

- [A] **AVCHD** ▶ Tab of the desired memory card ([A] or [B]) ▶  
Onscreen button of the content you want to play back  
([\*] **AVCHD** Movies) or ([\*] **MP4** Movies).

### 3 Look for the scene you want to play back.

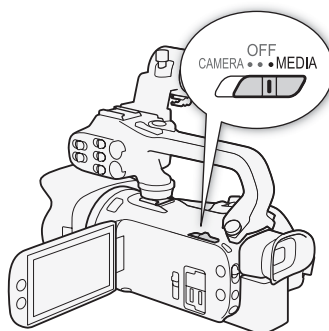

- 1 Index screen button. Displays the currently selected memory card and movie format. Press to change the index screen.
- 2 Drag your finger left/right for the next/previous index page.
- 3 Display the next/previous index page.
- 4 Scene information.
- 5 Recording date (for AVCHD movies) or folder name (for MP4 movies; see *About folder names* in the following sidebar).
- 6 Icon indicating a scene recorded using the [FUNC.] ▶ [Image Effects] ▶ [Looks] ▶ [Highlight Priority] look.

### 4 Touch the desired scene to play it back.

- The camcorder will play back the scene selected and continue until the end of the last scene in the index screen.
- Touch the screen to display the playback controls. During playback, the playback controls will disappear automatically after a few seconds without operation. In playback pause, touch the screen again to hide the playback controls.

### Playing back scenes recorded using the [Highlight Priority] look

When playing back a scene recorded using the [FUNC.] ➤ [Image Effects] ➤ [Looks] ➤ [Highlight Priority] look, you can use the [FUNC.] ➤ [MENU] ➤ [↶] ➤ [View Assistance] setting to display the picture on the camcorder's screen with more accurate colors. When playing back such a scene on an external monitor, we recommend increasing the monitor's overall brightness.

### About folder names

MP4 movies and photos are saved as files in folders. The folder names appear in a format such as "101\_1025." The first three digits indicate the folder number and the last four digits indicate the month and day (October 25, for the example folder above).

### During playback:

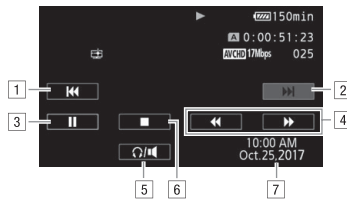

- 1 Jump to the beginning of the scene. Double-tap to jump to the previous scene.
- 2 Jump to the beginning of the next scene.
- 3 Pause the playback.
- 4 Fast playback\* backward/forward.
- 5 Display the volume controls ( 95).
- 6 Stop the playback.
- 7 Data code ( 86)

\* Touch several times to increase the playback speed to approximately 5x → 15x → 60x normal speed.

### Adjusting the volume

- 1 During playback, touch the screen to display the playback controls.
- 2 Touch [🔊/🔇].
- 3 Touch [🔊]/[🔇] or [🔊🔊]/[🔊🔊🔊] to adjust the volume and then touch [↶].

**During playback pause:**

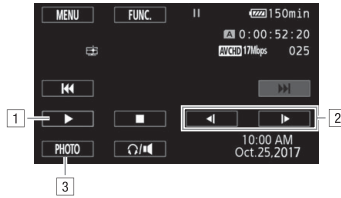

- 1 Resume playback.
- 2 Slow playback\* backward/forward.
- 3 Capture the displayed frame as a photo (97).

\* Touch several times to increase the playback speed 1/8 → 1/4 the normal speed.

**Displaying scene information**

- 1 In either the AVCHD or MP4 movie index screen, touch [i].
- 2 Touch the desired scene.
  - The scene information screen appears.
  - If the optional GP-E2 GPS Receiver was attached to the camcorder during recording, GPS information will also appear.
  - Touch ◀/▶ to select the previous/next scene.
- 3 Touch [↔] twice when finished.

**! IMPORTANT**

- You may not be able to play back with this camcorder movies recorded on a memory card using another device.

**i NOTES**

- You can turn off the recording date and time display or change the information displayed with the [MENU] ▶ [ ] ▶ [Data Code] setting. Note that available options depend on the type of recording.
- Depending on the recording conditions, you may notice brief stops in video or sound playback between scenes.
- During fast/slow playback, you may notice some anomalies (blocky video artifacts, banding, etc.) in the playback picture.
- The speed indicated on the screen is approximate.
- Slow reverse playback will look the same as continuous frame reverse.



## Capturing Photos During Movie Playback

You can capture a photo while a movie is being played back.

- 1 Play back the scene from which you want to capture the photo.
- 2 Pause the playback at the point where you want to capture the photo.
- 3 Touch [PHOTO].
- 4 Touch [■] to stop the playback.

### NOTES





- The size of the captured photos will be 1920x1080.
- The date of the photos will reflect the date and time of recording of the original scene.
- Photos captured from a scene with a lot of fast movement may be blurred.
- Photos will be recorded on the memory card selected for recording photos.

## Deleting Scenes



You can delete those scenes that you are not interested in keeping. Deleting scenes allows you also to free up space on the memory card.

Operating modes:   |   |   



### Deleting a Single Scene

- 1 Play back the scene you wish to delete ( 94).
- 2 Touch the screen to display the playback controls.
- 3 Open the [Delete] screen.  
  [FUNC.]  [Delete]
- 4 Touch [Yes].
  - The scene is deleted.
- 5 Touch [OK].

### Deleting Scenes from the Index Screen

- 1 Open the index screen ( 94).
  - To delete all the scenes recorded on a specific date, drag your finger left/right until a scene you want to delete appears.
- 2 Open the [Delete] screen.  
[FUNC.]  [Delete]
- 3 Touch the desired option.
  - When you touch [Select], perform the following procedure to select the individual scenes you want to delete before touching [Yes].
- 4 Touch [Yes].
  - Touch [Stop] to interrupt the operation while it is in progress. Some scenes may be deleted nevertheless.
  - The selected scenes are deleted.
- 5 Touch [OK].

#### To select individual scenes

- 1 Touch on the individual scenes you want to delete.
  - A checkmark  will appear on the scenes you touch. The total number of selected scenes will appear next to the  icon.
  - Touch a selected scene to remove the checkmark. To remove all checkmarks at once, touch [Remove All]  [Yes].
- 2 After selecting all the desired scenes, touch [OK].

## Options

**[date/folder name]** Delete all the scenes recorded on a particular date. For AVCHD movies, the date will appear in the onscreen button. For MP4 movies, the folder name (📁 95) will appear, with the last four digits indicating the month and day.

**[Select]** Select individual scenes to delete.

**[All Scenes]** Delete all the scenes.



### IMPORTANT

- **Be careful when deleting recordings. Once deleted, scenes cannot be recovered.**
- Save copies of important scenes before deleting them (📁 110).



### NOTES

- To delete all movies and make all recordable space available again you may prefer to initialize the memory card (📁 32).

## Dividing Scenes

You can divide AVCHD scenes in order to leave out the best parts and later cut out the rest.

Operating modes: CAMERA MEDIA | AVCHD MP4 | AUTO M CINEMA

1 Play back the desired scene (📖 94).

2 Pause the playback at the point where you want to divide the scene.

3 Open the screen for dividing scenes.

[FUNC.] ➡ [Divide]

4 Bring the scene to a precise point, if necessary.

- The point at which the movie will be divided is indicated by the ⏏ marker.
- Playback controls will appear on the screen (📖 96). Use any special playback modes as necessary to locate the desired point.

5 Divide the scene.

[🔪 Divide] ➡ [Yes]

- The video from the division point to the end of the scene will appear as a new scene in the index screen.

### NOTES

- When advancing/reversing frames while dividing the scenes, the interval between frames is about 0.5 seconds.
- If the scene cannot be divided at the point where you paused the playback, advance/reverse a frame and then divide the scene.
- During the playback of a scene that was divided, you may notice some anomalies in the picture/sound at the point where the scene was cut.
- Scenes that are too short (less than 3 seconds) cannot be divided.
- Scenes cannot be divided within 1 second from the beginning or the end of the scene.

## Trimming Scenes

You can trim MP4 scenes by removing everything up to a certain point or everything after a certain point.

Operating modes: CAMERA MEDIA | AVCHD **MP4** | AUTO M CINEMA

- 1 Play back the desired scene (📖 94).
- 2 Pause the playback.
- 3 Open the screen for trimming scenes.  
[FUNC.] ➤ [Trim]
- 4 Bring the scene to a precise point, if necessary.
  - The point at which the movie will be trimmed is indicated by the ▼ marker.
  - Playback controls will appear on the screen (📖 96). Use any special playback modes as necessary to locate the desired point.
- 5 Trim the scene.  
[Trim] ➤ Select whether to trim before ([Trim Before Marker]) or after ([Trim After Marker]) the ▼ marker ➤ Select whether to save as a new scene ([Save as New]) or overwrite the existing scene ([Overwrite])
  - If you chose to save the trimmed scene as a new scene, you can touch [Stop] to interrupt the operation while it is in progress.

# 6 External Connections

## Connecting to an External Monitor

When you connect the camcorder to an external monitor for playback, use the terminal on the camcorder that matches the one you wish to use on the monitor. Then, select the video signal output configuration. **XA11** The camcorder will automatically switch between the AV OUT and HDMI OUT terminals based on the external connection.

Operating modes: **CAMERA** **MEDIA** | **AVCHD** **MP4** | **AUTO** **M** **CINEMA**

## Connection Diagram

We recommend that you power the camcorder from a power outlet using the compact power adapter.

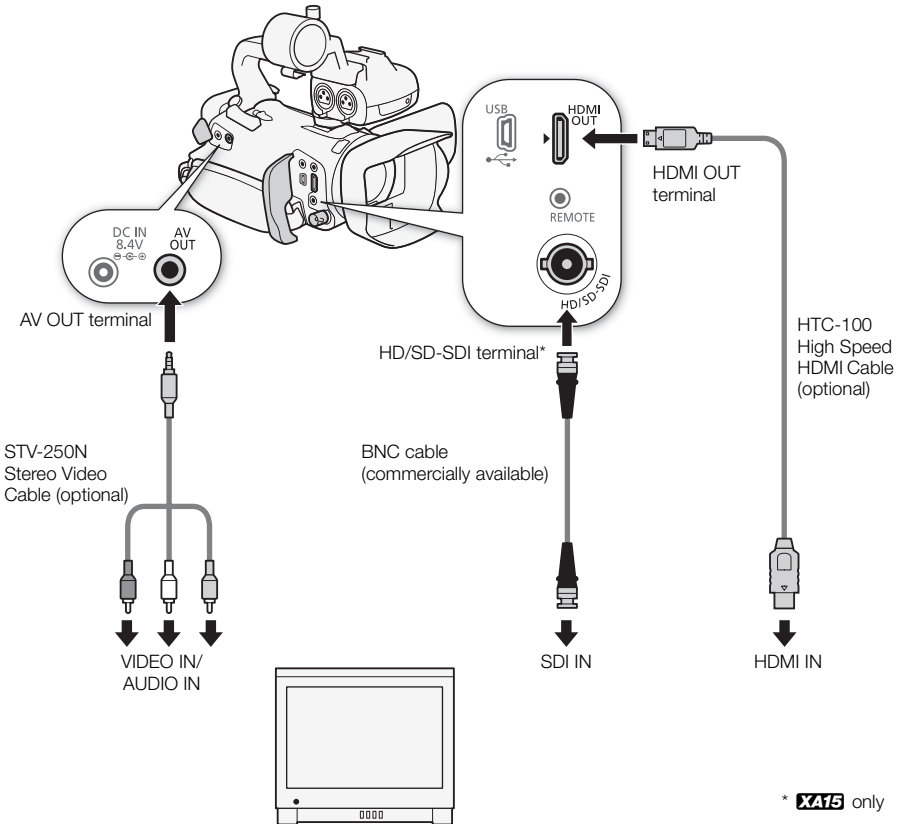

**XA15** Selecting the Terminal Used For Output

To output your recordings on an external monitor, you must first select which terminal you will use.

## 1 Open the [Output Terminal] screen.

[FUNC.] ➤ [MENU] ➤  ➤ [Output Terminal]

- Touching [FUNC.] is necessary only when performing the procedure in **CAMERA** mode.

## 2 Touch the desired option and then touch [X].

- If you selected [**SDI** HD/SD-SDI], [**SDI&HDMI** HD/SD-SDI & HDMI] or [**HDMI** HDMI], continue with the relevant procedure below to configure the output signal.

**Options** (↑ Default value)

[**OFF** Off] There is no output from any terminal.

[**SDI** HD/SD-SDI] There is output only from the HD/SD-SDI terminal.

[**SDI&HDMI** HD/SD-SDI & HDMI] There is output from the HD/SD-SDI and HDMI OUT terminals.

[**HDMI** HDMI]♦ There is output only from the HDMI OUT terminal.

[**AV** AV OUT] There is output only from the AV OUT terminal.

**XA15** Using the HD/SD-SDI Terminal

The digital signal output from the HD/SD-SDI terminal includes the video signal, audio signal and time code signal. If necessary, perform the following procedure to change the video output signal.

## 1 Open the [HD/SD-SDI Output] screen.

[FUNC.] ➤ [MENU] ➤  ➤ [HD/SD-SDI Output]

- Touching [FUNC.] is necessary only when performing the procedure in **CAMERA** mode.

## 2 Touch the desired option and then touch [X].

 NOTES

- You can use the [FUNC.] ➤ [MENU] ➤  ➤ [Output Onscreen Displays] setting to select whether onscreen displays are embedded in the output video signal.

**Using the HDMI OUT Terminal**

The HDMI™ OUT terminal also offers a digital connection and outputs both a video and audio signal. If you select [**A** Automatic], the output signal will automatically switch to HD or SD depending on the capability of the external monitor. In **CAMERA** mode, the audio output signal will be 2-channel linear PCM audio (16-bit, 48 kHz sampling).







## 1 Open the [HDMI Output] screen.

[FUNC.] ➤ [MENU] ➤  ➤ [HDMI Output]

- Touching [FUNC.] is necessary only when performing the procedure in **CAMERA** mode.

## 2 Touch the desired option and then touch [X].

**i** NOTES



- **XA15** When [FUNC.] ➤ [MENU] ➤  ➤ [Output Terminal] is set to  HD/SD-SDI & HDMI], the signal output from the HDMI OUT terminal will be determined by the [FUNC.] ➤ [MENU] ➤  ➤ [HD/SD-SDI Output] setting.
- In  mode, you can use the [FUNC.] ➤ [MENU] ➤  ➤ [HDMI Time Code] setting to include the time code in the signal output from the HDMI OUT terminal.
- The HDMI OUT terminal on the camcorder is for output only. Do not connect it to an HDMI output terminal on an external device, as this may damage the camcorder.
- There will be no video output from the AV OUT terminal while an external monitor is connected to the HDMI OUT terminal.
- Correct operation cannot be guaranteed when connecting the camcorder to DVI monitors.
- Video may not be output correctly depending on the monitor. In such case, use another terminal.
- If you selected an option other than [**A** Automatic] and the connected monitor is not compatible with the signal output from the camcorder, then HDMI output will stop.
- You can use the [FUNC.] ➤ [MENU] ➤  ➤ [Output Onscreen Displays] setting to select whether onscreen displays are embedded in the output video signal.

## Using the AV OUT Terminal

The AV OUT terminal outputs a down-converted analog video signal and audio signal for connection to monitors with a composite audio/video input.



## Audio Output

The camcorder can output audio from the HD/SD-SDI terminal (**XA15** only), HDMI OUT terminal, AV OUT terminal or  (headphone) terminal. When audio is output from the AV OUT terminal or  (headphone) terminal, you can configure the following settings.

### Synchronizing the Video with the Audio being Monitored

When audio is output from the AV OUT terminal or  (headphone) terminal, you can choose to synchronize the audio signal with the video signal or have the camcorder output the audio in real time. When the audio is output in real time, there will be a slight delay. Regardless of the setting, however, the audio and video signals recorded will be synchronized.

Operating modes:   |   |   

1 Open the [Monitor Delay] submenu.



[FUNC.]  [MENU]    [Monitor Delay]

- Touching [FUNC.] is necessary only when performing the procedure in  mode.

2 Touch the desired option and then touch .

**Options**  (Default value)

 **Line Out** Synchronizes the audio and video signals.

 **Normal**  Allows you to monitor the audio in real time.

### Selecting the Audio Channel

You can select the audio channel that is output from the AV OUT terminal or  (headphone) terminal.

Operating modes:   |   |   



POINTS TO CHECK

- When performing this procedure in  mode, set the INPUT terminal ON/OFF switch to ON.



1 Open the [Audio Output CH] submenu.

[FUNC.]  [MENU]    [Audio Output CH]

- Touching [FUNC.] is necessary only when performing the procedure in  mode.

2 Touch the desired option and then touch .

**Options**  (Default value)

 **CH1/CH2**  CH1 audio is output from the left channel and CH2 audio is output from the right channel.

 **CH1/CH1** CH1 audio is output from both the left and right channels.

 **CH2/CH2** CH2 audio is output from both the left and right channels.

 **AII/AII** CH1 and CH2 audio is mixed and output from both the left and right channels.

 NOTES

- If you set an assignable button to [Audio Output CH] ( 91), you can press the button to change the audio channel directly.

# 7 Photos

## Viewing Photos

Operating modes: **CAMERA** **MEDIA** | **AVCHD** **MP4** | **AUTO** **M** **CINEMA**

- 1 Set the power switch to MEDIA.
  - The AVCHD or MP4 movie index screen will appear.
- 2 Open the photo index screen.
  - [A] **AVCHD** ➤ Tab of the desired memory card ([A] or [B]) ➤
  - [📷] Photos
- 3 Look for the photo you want to play back.

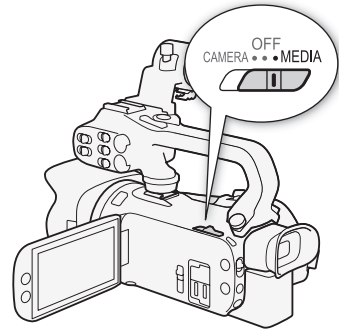

- 1 Index screen button. Displays the currently selected memory card. Press to change the index screen.
- 2 Drag your finger left/right for the next/previous index page\*.
- 3 Display the next/previous index page.
- 4 Folder name (📁 95).

\* While browsing through index pages, a scroll bar will appear at the bottom of the screen for a few seconds. When you have a large number of photos it may be more convenient to drag your finger along the scroll bar.



- 4 Touch the photo you wish to view.
  - The photo is displayed in single photo view.
  - Drag your finger left/right to browse through the photos one by one.
  - If the optional GP-E2 GPS Receiver was attached to the camcorder during recording, GPS information will also appear.

To return to the index screen from single photo view

- 1 Touch the screen to display the playback controls.
- 2 Touch [📷].

## Photo Jump Function

When you have recorded a large number of photos, you can jump easily through the photos using the scroll bar.

- 1 Touch the screen to display the playback controls.
- 2 Touch [].
- 3 Drag your finger left and right along the scroll bar and then touch [].

108



### IMPORTANT



- The following image files may not be displayed correctly.
  - Images not recorded with this camcorder.
  - Images edited on a computer.
  - Images whose file names have been changed.

## Deleting Photos

You can delete those photos that you are not interested in keeping.

Operating modes: CAMERA MEDIA | AVCHD MP4 | AUTO M CINEMA

### Deleting a Single Photo

- 1 In single photo view, select the photo you want to delete.
- 2 Touch the screen to display the playback controls.
- 3 Open the [Delete] screen.  
[FUNC.] ➤ [Delete]
- 4 Touch [ Proceed] and then touch [Yes].
  - The photo is deleted.
- 5 Drag your finger left/right to select another photo to delete or touch [].

### Deleting Photos from the Index Screen

- 1 Open the photo index screen.
- 2 Open the [Delete] screen.  
[FUNC.] ➤ [Delete]
- 3 Touch the desired option and then touch [Yes].
  - When you select [Select], perform the following procedure to select the individual photos you want to delete before touching [Yes].
  - Touch [Stop] to interrupt the operation while it is in progress. Some photos will be deleted nevertheless.
- 4 Touch [OK].

#### To select individual photos

- 1 Touch on the individual photos you want to delete.
  - A checkmark ✓ will appear on the photos you touch. The total number of selected photos will appear next to the  icon.
  - Touch a selected photo to remove the checkmark. To remove all checkmarks at once, touch [Remove All] ➤ [Yes].
- 2 After selecting all the desired photos, touch [OK].

#### Options

**[folder name]** Delete all the photos taken on a particular date. The folder name ( 95) will appear in the onscreen button, with the last four digits indicating the month and day.

**[Select]** Select individual photos to delete.

**[All Photos]** Delete all the photos.



#### IMPORTANT

- **Be careful when deleting photos. Deleted photos cannot be recovered.**
- Photos that were protected with other devices cannot be deleted with this camcorder.

## Saving Movies to a Computer

You can use the software Data Import Utility to save your AVCHD and MP4 scenes to a computer.

With the software, you can do the following.

- Save scenes to a computer (all scenes/new scenes only).
- Join relay scenes (either AVCHD or MP4 format) that were saved on separate memory cards (□ 41) and save them as a single scene.
- Join multiple video stream files of a single scene (either AVCHD or MP4 format) split because of the 4 GB maximum file size restriction and save them as a single scene.

Access PIXELA's website below to download the software and to check the latest information.

[http://www.pixela.co.jp/oem/canon/e/index\\_biz.html](http://www.pixela.co.jp/oem/canon/e/index_biz.html)

Check the Data Import Utility Software Guide<sup>1</sup> for details on features, system requirements, installation and how to use the software.

<sup>1</sup> The software guide is a PDF file in the [Manual] folder of the downloaded compressed file that contains the software.



### IMPORTANT

- Before saving scenes to your computer with Data Import Utility using a memory card reader or your computer's memory card slot, do not access or manipulate the files on the memory card with other software. Failing to do so may result in not being able to save the files to your computer.
- When the camcorder is connected to a computer:
  - Do not open the double memory card slot cover.
  - Do not change or delete any of the camcorder's folders or files directly from the computer as this may result in permanent data loss.
  - Do not set the computer in **Sleep** or **Hibernate** mode (Windows) and do not activate the **Sleep** function (macOS).
- If you wish to use the recordings on your computer, make copies of them first. Use the copied files, retaining the originals.

## Transferring Movies to the Computer

After you install the software Data Import Utility, you can save movies to your computer.

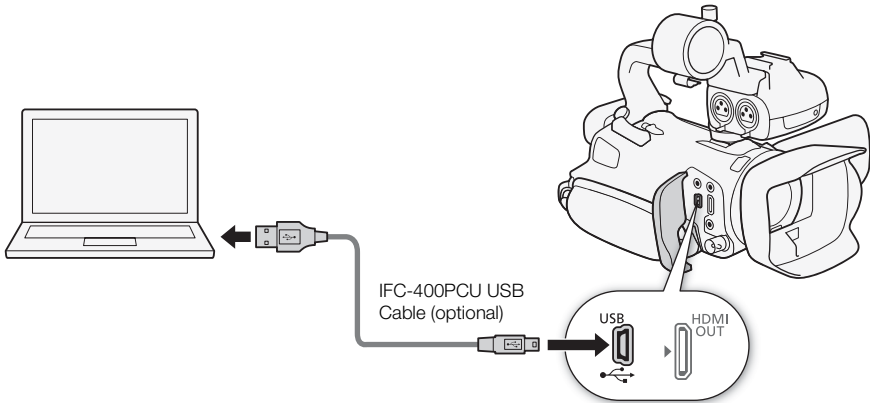

- 1 Camcorder: Power the camcorder using the compact power adapter.
- 2 Camcorder: Set the power switch to MEDIA.
- 3 Camcorder: Open the desired movie index screen (📖 94).
- 4 Connect the camcorder to the computer using the optional IFC-400PCU USB Cable.
- 5 Camcorder: Touch [All (for PC only)].
- 6 Computer: Click the 📁 icon on the desktop to start Data Import Utility.
- 7 Computer: Use Data Import Utility to save the movies onto the computer.
  - Follow the onscreen instructions and refer to the Data Import Utility Software Guide (PDF file).

## Copying Recordings Between Memory Cards

You can copy recordings from one memory card to the other.

### Copying Scenes from the Movie Index Screen

Operating modes: CAMERA MEDIA | AVCHD MP4 | AUTO M CINEMA

- 1 Open the desired movie index screen (📖 94).
  - To copy all the scenes recorded on a specific date, drag your finger left/right until a scene you want to copy appears.
- 2 Open the screen to copy scenes.  
[FUNC.] ➤ [Copy (A → B)] or [Copy (B → A)]
- 3 Touch the desired option and then touch [Yes].
  - When you select [Select], perform the following procedure to select the individual scenes you want to copy before touching [Yes].
  - Touch [Stop] to interrupt the operation while it is in progress.
- 4 Touch [OK].

#### To select individual scenes

- 1 Touch on the individual scenes you want to copy.
  - A checkmark ✓ will appear on the scenes you touch. The total number of selected scenes will appear next to the ☑ icon.
  - Touch a selected scene to remove the checkmark. To remove all checkmarks at once, touch [Remove All] ➤ [Yes].
- 2 After selecting all the desired scenes, touch [OK].

#### Options

**[date/folder name]** Copy all the scenes recorded on a particular date. For AVCHD movies, the date will appear in the onscreen button. For MP4 movies, the folder name (📖 95) will appear in the onscreen button, with the last four digits indicating the month and day.

**[Select]** Select individual scenes to copy.

**[All Scenes]** Copy all the scenes.

### Copying a Single Photo

Operating modes: CAMERA MEDIA | AVCHD MP4 | AUTO M CINEMA

- 1 In single photo view, select the photo you want to copy.
- 2 Touch the screen to display the playback controls.
- 3 Open the screen to copy photos.  
[FUNC.] ➤ [Copy (A → B)] or [Copy (B → A)]
- 4 Touch [📄 Proceed] and then touch [Yes].
  - The photo is copied.
- 5 Drag your finger left/right to select another photo to copy or touch [✕].



## Copying Photos from the Index Screen

Operating modes: CAMERA MEDIA | AVCHD MP4 | AUTO M CINEMA

- 1 Open the desired photo index screen (☞ 107).
- 2 Open the screen to copy photos.  
[FUNC.] ➤ [Copy (A ➤ B)] or [Copy (B ➤ A)]
- 3 Touch the desired option and then touch [Yes].
  - When you select [Select], perform the following procedure to select the individual photos you want to copy before touching [Yes].
  - Touch [Stop] to interrupt the operation while it is in progress.
  - The selected photos are copied.
- 4 Touch [OK].

### To select individual photos

- 1 Touch on the individual photos you want to copy.
  - A checkmark ✓ will appear on the photos you touch. The total number of selected photos will appear next to the ☑ icon.
  - Touch a selected photo to remove the checkmark. To remove all checkmarks at once, touch [Remove All] ➤ [Yes].
- 2 After selecting all the desired photos, touch [OK].

### Options

**[folder name]** Copy all the photos taken on a particular date. The folder name (☞ 95) will appear in the onscreen button, with the last four digits indicating the month and day.

**[Select]** Select individual photos to copy.

**[All Photos]** Copy all the photos.

### NOTES

- In the following cases, you will not be able to copy recordings to the memory card:
  - If the double memory card slot is open.
  - If the LOCK switch on the memory card is set to prevent writing.
  - If a file number (☞ 122) cannot be created because the number of folders and files in the memory card has reached its maximum.
- If there is not enough space on the memory card, as many photos as possible will be copied before stopping the operation.

## Converting Movies to MP4 Format

You can convert AVCHD movies into MP4 movies or even convert (resize) MP4 movies into smaller MP4 movies. This is convenient, for example, when you want to upload the MP4 movies to the Web. When you convert movies on one memory card, they will be saved to the other memory card. While converting movies, the camcorder can add a cinema-look filter to the converted movie.

Operating modes: CAMERA MEDIA | AVCHD MP4 | AUTO M CINEMA

1 Open the desired movie index screen (📖 94).

2 Open the screen to convert scenes.

[FUNC.] ➤ [Convert to MP4 ([A] ➤ [B])] or [Convert to MP4 ([B] ➤ [A])] ➤ Desired video quality (resolution and bit rate) of converted movies\*

\* Before selecting the video quality, you can touch [Join Scenes] to join the converted movies into one movie.

- When converting movies with a frame rate of 23.98P, the converted MP4 movie will also have a frame rate of 23.98P. When converting movies with other frame rates, the converted MP4 movie will have a frame rate of 29.97P.

3 Touch the individual scenes you want to convert.

- A checkmark ✓ will appear on the scenes you touch. The total number of selected scenes will appear next to the  icon.
- Touch a selected scene to remove the checkmark. To remove all checkmarks at once, touch [Remove All] ➤ [Yes].

4 After selecting all the desired scenes, touch [OK] and then touch [Next].

- To add a cinema-look filter (📖 45): Touch [FILTER 1] and then select the desired filter. Touch the button again to deactivate the filter.

5 Touch [START] to convert the scene.

- Touch [STOP] to interrupt the operation while it is in progress.

6 Touch [OK].

Recording mode before conversion		Video quality options
AVCHD	MP4	
28 Mbps LPCM (59.94P), 28 Mbps (59.94P)	35 Mbps (59.94P), 8 Mbps (59.94P)	Cannot be converted
24 Mbps LPCM, 17 Mbps, 5 Mbps	24 Mbps, 17 Mbps	24 Mbps, 17 Mbps, 4 Mbps, 3 Mbps
–	4 Mbps	4 Mbps, 3 Mbps
–	3 Mbps	3 Mbps

### NOTES

- Scenes with a frame rate of 23.98P can be joined only with other scenes with a frame rate of 23.98P. They cannot be joined with scenes with other frame rates.
- While converting movies, video and audio signals will not be output from the camcorder's terminals.
- When you add a cinema-look filter while converting the movie, the effect may differ from when recording a movie.

## Copying Recordings to an External Video Recorder

Operating modes: CAMERA MEDIA | AVCHD MP4 | AUTO M CINEMA

### In High Definition

Connect the camcorder to Blu-ray Disc recorders and other AVCHD-compatible digital video recorders using the optional IFC-400PCU USB Cable to make copies of your movies in high definition. If the external digital video recorder has an SD memory card slot\*, you can use the memory card to copy your movies without connecting the camcorder.

\* Make sure the external device is compatible with the type of memory card used.

### Connecting

- 1 Power the camcorder using the compact power adapter.
- 2 Open the desired AVCHD movie index screen (📖 94).
- 3 Connect the camcorder to the digital video recorder using the USB cable.
- 4 Select the memory card that contains the scenes you want to copy.
  - Select an option other than [All (for PC only)].

### Recording

Details will vary depending on the device used so be sure to refer to the instruction manual of the digital video recorder.

### In Standard Definition

You can copy your movies by connecting the camcorder to a digital video recorder with analog audio/video inputs. Video output will be in standard definition, although the original scenes may be in high definition.

### Connecting

Connect the camcorder to the digital video recorder using the optional STV-250N Stereo Video Cable. Refer to *Connection Diagram* (📖 102).

### Recording

- 1 Camcorder: Power the camcorder using the compact power adapter.
- 2 External recorder: Load a blank cassette or disc and set the recorder to record standby mode.
- 3 Camcorder: Open the desired movie index screen (📖 94).
  - **X415** Verify that [MENU] ➤ [📄] ➤ [Output Terminal] is set to [AV AV OUT].
- 4 Camcorder: Locate the scene you wish to copy and pause the playback just before the desired scene.
- 5 Camcorder: Resume playback.
  - By default, the data code will be embedded in the output video signal. You can change this using the [MENU] ➤ [📄] ➤ [Data Code] setting.

6 External recorder: Start recording when the scene you wish to copy appears; stop recording when it ends.

7 Camcorder: Stop playback.

# 9 Additional Information



































## Appendix: Menu Options Lists

Menu items not available appear grayed out. For details about how to select an item, refer to *Using the Menus* (□ 29). For details about each function, see the reference page. Menu options without a reference page are explained after the tables. Underlined menu options indicate default values.

117

### FUNC. Menu

#### FUNC. Menu - Mode

Onscreen button	Setting options/Function	AUTO	M	CINEMA	
[MENU]	Open the setup menus	●	●	●	30
[Rec. Programs]	[ <b>P</b> Programmed AE], [ <b>Tv</b> Shutter-Pri. AE], [ <b>Av</b> Aperture-Pri. AE], [ <b>M</b> Manual Exposure]	–	●	●	58, 60
	[  Portrait], [  Sports], [  Night Scene], [  Snow], [  Beach], [  Sunset], [  Low Light], [  Spotlight], [  Fireworks]	–	●	–	65
[  BLC Always On]	[ON], [ <u>OFF</u> ]	–	●	●	62
[WB White Balance]	[ <b>AWB</b> Automatic], [  Daylight], [  Shade], [  Cloudy], [  Fluorescent], [  Fluorescent H], [  Tungsten], [ <b>K</b> Color Temperature], [  Set 1], [  Set 2]	–	●	●	63
[ <b>AGC</b> AGC Limit]	[ <b>A</b> ] (automatic), [ <b>M</b> ] (manual)	–	●	●	57
[  Focus]	Touch AF frame; [ <b>MF</b> ] (manual focus): Toggle on or off; [ <b>PEAK</b> ] (peaking): Toggle on or off; [  ] (settings): [Peaking and B&W], [Peaking Color] When [ <b>MF</b> ] is on - [SET] (focus preset) When [SET] is on - [ON] (return to preset focus position)	–	●	●	47
[  Exposure]	Touch AE frame; [ <b>M</b> ] (exposure compensation): Toggle on or off, [  ] (settings): [AE Lock (Touch)], [Zebra Pattern]; [  Z70] or [  Z100] (zebra pattern): Toggle on or off	–	●	●	61
[AUDIO Audio Scene] <sup>1, 2</sup>	[  Standard], [  Music], [  Speech], [  Forest and Birds], [  Noise Suppression]	●	●	●	76
	[  Custom Setting]	–	●	●	
[  Mic Level] <sup>1</sup>	[ <b>A</b> ] (automatic), [ <b>M</b> ] (manual) When [ <b>A</b> ] is on - [Audio Level Indicator]: Toggle on or off	–	●	●	77
[ZOOM] <sup>2</sup>	Zoom controls, [START]/[STOP] control (for movies)	●	●	●	54
	[PHOTO] control (for photos)	●	●	–	
[Image Stabilizer]	[  Dynamic], [  Standard], [  Off]	–	●	●	56

Onscreen button	Setting options/Function	AUTO	M	CINEMA	
[Image Effects]	[ON], [OFF] When [ON] is selected - [Looks]: [Standard], [Highlight Priority], [Wide DR] [Color Depth], [Sharpness], [Contrast], [Brightness]: -2 to +2 (±0)	–	●	–	67

<sup>1</sup> Option available only for recording movies.

<sup>2</sup> The setting is maintained when the camcorder is switched from or mode to mode.  
(Except for Custom Setting) under [AUDIO Audio Scene].)

## FUNC. Menu - Mode (Movies)

Onscreen button	Movie Index Screen	Playback Pause	
[Copy (A → B)]	<date/folder name>, [Select], [All Scenes]	–	112
[Copy (B → A)]			
[Convert to MP4 (A → B)]	Conversion quality settings, [Join Scenes]	–	114
[Convert to MP4 (B → A)]			
[Delete]	<date/folder name>, [Select], [All Scenes]	[This Scene]	98
[Divide]	–	●	100
[Trim]	–	●	101















## FUNC. Menu - Mode (Photos)

Onscreen button	Photo Index Screen	Single Photo View	
[Copy (A → B)]	<folder name>, [Select], [All Photos]	●	112
[Copy (B → A)]			
[Delete]			109

## Setup Menus

### Camera Setup

Menu item	Setting options	
[Digital Zoom]	[OFF Off], [400x 400x], [ZOOM Digital Tele-conv.]	–
[Soft Zoom Control]	[OFF Off], [START Start], [STOP Stop], [START/STOP Start & Stop]	55
[Zoom Speed Level]	[Fast], [Normal], [Slow]	53
[Zoom Rocker Zoom Speed]	[VAR ] (variable speed), [CONST ] (constant speed) When [CONST ]: 1-16 (8)	53
[Handle Rocker Zoom Speed]	[OFF ] (off), [CONST ] (constant) When [CONST ]: 1-16 (8)	54
[High-Speed Zoom]	[ON On], [OFF Off]	54
[AF Mode]	[LAF Instant AF], [MAF Medium AF], [AF Normal AF]	49

Menu item	Setting options	
[Focus Assistance]	[ <b>ON</b> On], [ <b>OFF</b> Off]	–
[Face Detection & Tracking]	[ <b>ON</b> On  ], [ <b>OFF</b> Off]	50
[Auto Backlight Correction]	[ <b>ON</b> On], [ <b>OFF</b> Off]	–
[Auto Slow Shutter]	[ <b>ON</b> On], [ <b>OFF</b> Off]	–
[Flicker Reduction]	[ <b>OFF</b> Off], [ <b>A</b> Automatic]	–
[ND Filter]	[ <b>A</b> Automatic], [ <b>OFF</b> Off]	–
[Conversion Lens]	[ <b>Tele</b> TL-H58], [ <b>Wide</b> WA-H58], [ <b>OFF</b> Off]	–
[Intelligent IS]	[  With  ], [  Without  ]	37
[Onscreen Markers]	[ <b>OFF</b> Off], [  Level (Gray)], [  Level (Black)], [  Grid (Gray)], [  Grid (Black)]	–
[IR Light]	[ <b>ON</b> On], [ <b>OFF</b> Off]	–
[IR Rec Color]	[ <b>WHITE</b> White], [ <b>GREEN</b> Green]	87
[Built-in Mic Wind Screen]	[ <b>H</b> Auto (High)], [ <b>L</b> Auto (Low)  ], [ <b>OFF</b> Off  ]	79
[Built-in Mic Att.]	[ <b>A</b> Automatic], [ <b>ON</b> On], [ <b>OFF</b> Off]	80
[Built-in Mic Freq. Response]	[ <b>NORM</b> Normal], [ <b>LB</b> Boost LF Range], [ <b>LC</b> Low Cut Filter], [ <b>MB</b> Boost MF Range], [ <b>LHB</b> Boost HF+LF Range]	79
[Built-in Mic Directionality]	[  Monaural], [ <b>NORM</b> Normal], [  Wide], [  Zoom]	78
[MIC Att.]	[ <b>A</b> Automatic], [ <b>ON</b> On], [ <b>OFF</b> Off]	81
[MIC Low Cut]	[ <b>ON</b> On], [ <b>OFF</b> Off]	80
[MIC Terminal Input]	[ <b>LINE</b> External Audio], [ <b>MIC</b> Microphone]	76
[CH2 Input]	[ <b>INPUT1</b> INPUT 1], [ <b>INPUT2</b> INPUT 2], [ <b>INT/MIC</b> Built-in Mic/MIC]	74
[INPUT 1 Mic Trimming]	[ <b>+12dB</b> +12 dB], [ <b>+6dB</b> +6 dB], [ <b>0dB</b> 0 dB], [ <b>-6dB</b> -6 dB], [ <b>-12dB</b> -12 dB]	75
[INPUT 2 Mic Trimming]	[ <b>+12dB</b> +12 dB], [ <b>+6dB</b> +6 dB], [ <b>0dB</b> 0 dB], [ <b>-6dB</b> -6 dB], [ <b>-12dB</b> -12 dB]	75
[INPUT 1 Mic Att.]	[ <b>ON</b> On], [ <b>OFF</b> Off]	75
[INPUT 2 Mic Att.]	[ <b>ON</b> On], [ <b>OFF</b> Off]	75
[INPUT 1/2 ALC Link]	[ <b>LINK</b> Linked], [ <b>SEP.</b> Separated]	74
[INPUT 1/2 Limiter]	[ <b>ON</b> On], [ <b>OFF</b> Off]	75

**[Digital Zoom]:** Determines the operation of the digital zoom.

- When you zoom, once you exceed the optical zoom range, the camcorder will automatically switch to digital zoom.
- With the digital zoom the image is digitally processed, so the image resolution will deteriorate the more you zoom in.
- Digital zoom is available only for movies.

**[Focus Assistance]:** When focus assistance is activated, the image at the center of the screen is magnified to help you focus manually ( 47).

- Using focus assistance will not affect the recordings. It will be cancelled automatically after 4 seconds or when you start recording.
- Focus assistance is available only for movies.

**[Auto Backlight Correction]:** When set to **[ON On]**, the camcorder will automatically detect and compensate the exposure for backlit subjects. This is useful in situations in which the subject is not constantly backlit.

- When **[FUNC.]** ➤ **[Image Effects]** ➤ **[Looks]** is set to **[Wide DR]** or **[Highlight Priority]**, this setting is not available.

**[Auto Slow Shutter]:** The camcorder automatically uses slow shutter speeds to obtain brighter recordings in places with insufficient lighting.

- Minimum shutter speed used: 1/30; 1/15 when the frame rate is set to PF29.97 or 29.97P; 1/12 when the frame rate is set to 23.98P.
- The auto slow shutter can be activated only during **[AUTO]** mode, when the recording program is set to **[P Programmed AE]** or during infrared mode.
- If a trailing afterimage appears, set the slow shutter to **[OFF Off]**.
- If  (camcorder shake warning) appears, we recommend stabilizing the camcorder, for example, by mounting it on a tripod.

**[Flicker Reduction]:** When set to **[A Automatic]**, the camcorder will automatically detect and reduce flicker.

- When recording under light sources such as fluorescent, mercury or halogen lamps, the screen may flicker depending on the shutter speed. You may be able to avoid flicker by setting the shutter speed mode to a value matching the frequency of the local electrical system: 1/100 for 50 Hz systems, 1/60 for 60 Hz systems.

**[ND Filter]:** Available in any recording program other than the Special Scene recording programs. When set to **[A Automatic]**, ND filter settings will be available when the aperture value is F4.0.

**[Conversion Lens]:** When you attach to the camcorder the optional TL-H58 Tele-converter or WA-H58 Wide Attachment, set the appropriate conversion lens setting. The camcorder will then optimize the image stabilization and adjust the minimum object distance. The minimum object distance throughout the entire zoom range will be 130 cm (4 ft. 3 in.) for the Tele-converter and about 60 cm (2 ft.) for the Wide Attachment. When you select **[Wide WA-H58]** and you zoom in, the zoom position marker will stop before reaching the end of the zoom bar.

- This Wide Attachment decreases the focal length by a factor of 0.75.
- When you select a setting other than **[OFF Off]**, the AF mode is automatically set to **[AF Normal AF]**.
- The approximate subject distance displayed on the screen will change depending on the setting. If you are not using an optional lens, select **[OFF Off]**.

**[Onscreen Markers]:** You can display a grid or a horizontal line at the center of the screen. Use the markers as a reference to make sure your subject is framed correctly (vertically and/or horizontally).









- Using the onscreen markers will not affect the recordings.

**[IR Light]:** Turns the infrared light on and off. The light is located on the handle unit so make sure you attach it to the camcorder in advance.

- If set to **[ON On]**, the infrared light is always on when the camcorder is in infrared mode.



 /  Playback Setup

Menu item	Setting options	MEDIA		
				
[Data Code]	For AVCHD movies and photos: [ <b>OFF</b> Off], [  Date], [  Time], [  Date and Time], [  Camera Data] For MP4 movies: [ <b>OFF</b> Off], [  Date]	●	●	–
[TV Type]	[ <b>4:3</b> 4:3 TV], [ <b>16:9</b> Wide TV]	●	●	–

**[Data Code]:** Displays the date and/or time when the scene or photo was recorded.

[ Camera Data]: Displays the aperture (f-stop) and shutter speed used when recording the scene or photo.





**[TV Type]:** When you connect the camcorder to a TV using the optional STV-250N Stereo Video Cable, select the setting according to the type of TV in order to display the picture in full and in the correct aspect ratio.

[**4:3** 4:3 TV]: TV sets with 4:3 aspect ratio.

[**16:9** Wide TV]: TV sets with 16:9 aspect ratio.

- When the TV type is set to [**4:3** 4:3 TV], during the playback of video originally recorded with an aspect ratio of 16:9, the picture will not be displayed fullscreen.

 Recording Setup

Menu item	Setting options	CAMERA	MEDIA		
					
[Movie Format]	[ <b>AVCHD</b> AVCHD], [ <b>MP4</b> MP4]	●	–	–	34
[Recording Mode]	For AVCHD movies: [28 Mbps LPCM (59.94P)], [28 Mbps (59.94P)], [24 Mbps LPCM], [24 Mbps], [17 Mbps], [5 Mbps] For MP4 movies: [35 Mbps (59.94P)], [24 Mbps], [17 Mbps], [8 Mbps (59.94P)], [4 Mbps], [3 Mbps]	●	–	–	40
[Recording Media]	[  Rec Media for Movies]: [ <b>A</b> Mem. Card A], [ <b>B</b> Mem. Card B]	●	–	–	33
	[  Rec Media for Photos]: [ <b>A</b> Mem. Card A], [ <b>B</b> Mem. Card B]	●	●	●	
[Dual/Relay Recording]	[Standard Recording], [Dual Recording], [Relay Recording]	●	–	–	41
[Frame Rate]	For AVCHD movies: [ <b>59.94i</b> 59.94i], [ <b>PF29.97</b> PF29.97], [ <b>23.98P</b> 23.98P] For MP4 movies: [ <b>29.97P</b> 29.97P], [ <b>23.98P</b> 23.98P]	●	–	–	42

Menu item	Setting options	CAMERA			MEDIA		📖
		📷	📹	📺	📷	📹	
[Slow & Fast Motion]	When the frame rate is 59.94P: [OFF], [x2], [x2.5] When the frame rate is 29.97P: [OFF], [x0.5], [x1.25], [x2], [x4], [x10], [x20], [x60], [x120], [x1200] When the frame rate is 23.98P: [OFF], [x0.4], [x0.8]	●	–	–			43
[Video Snapshot Length]	[ <b>2sec</b> 2 sec], [ <b>4sec</b> 4 sec], [ <b>8sec</b> 8 sec]	●	–	–			84
[Time Code Mode]	[ <b>PRESET</b> Preset], [ <b>REGEN</b> Regen.]	●	–	–			69
[Time Code Running Mode]	[ <b>RECRUN</b> Rec Run], [ <b>FREE RUN</b> Free Run]	●	–	–			69
[DF/NDF]	[ <b>DF</b> DF], [ <b>NDF</b> NDF]	●	–	–			70
[Initial Time Code]	00:00:00.00 to 23:59:59.29 [Reset]	●	–	–			69
[User Bit Output Mode]	[ <b>FIXED</b> Fixed], [ <b>PULLDOWN</b> Pulldown]	●	–	–			122
[User Bit Type]	[ <b>SET</b> Setting], [ <b>TIME</b> Time], [ <b>DATE</b> Date]	●	–	–			71
[Color Bars]	[ <b>OFF</b> Off], [ <b>SMPTE</b> SMPTE], [ <b>ARIB</b> ARIB]	●	–	–			83
[1 kHz Tone]	[ <b>-12dB</b> -12 dB], [ <b>-18dB</b> -18 dB], [ <b>-20dB</b> -20 dB], [ <b>OFF</b> Off]	●	–	–			83
[File Numbering]	[ <b>📷</b> Reset], [ <b>📹</b> Continuous]	●	●	●			–
[Available Space in Memory]	[ <b>[A]</b> ], [ <b>[B]</b> ]	●	–	–			–
[Used Space in Memory]	[ <b>[A]</b> ], [ <b>[B]</b> ]	–	●	●			–
[Initialize <b>SD</b> ]	[ <b>[A]</b> Mem. Card A], [ <b>[B]</b> Mem. Card B]	●	●	●			32

**[File Numbering]:** MP4 movies and photos are saved as files in folders. You can select the file numbering method for those files. File numbers appear on screens in playback mode in a format such as "101-0107". The first three digits indicate the folder number and the last four digits are different for each file in a folder.

[ **📷** Reset]: File numbers will restart from 100-0001 every time you record on a memory card that has been initialized.

[ **📹** Continuous]: File numbers will continue from the number following that of the last file recorded with the camcorder.

- If the memory card you insert already contains a file with a larger number, a new file will be assigned a number one higher than that of the last file on the memory card.
- We recommend using the [ **📹** Continuous] setting.
- When you use a computer to view the contents of a memory card with MP4 movies or photos, an MP4 movie with a file number of "100-0107" recorded on October 25th will be saved in the "DCIM\100\_1025" folder as the file "MVI\_0107.MP4"; a photo with the same file number will be saved in the same folder as the file "IMG\_0107.JPG".

- Folders can contain up to 500 files (MP4 movies and photos combined) and a new folder is created every time a folder exceeds this number.
- The first three digits of the file number range from 100 to 999 and the last four digits range from 0001 to 9999. File numbers are automatically assigned consecutive numbers.

**[Available Space in Memory]/[Used Space in Memory]:** Displays a screen where you can verify how much of the memory card is currently available for recording or how much is in use ( total recording time and total number of photos).

- Estimated figures about available movie recording time and available number of photos are approximate and based on the recording mode currently in use and a photo size of 1920x1080.
- You can also check the memory card's Speed Class.

## System Setup

Menu item	Setting options	CAMERA	MEDIA		
[Language	[Česky], [Dansk], [Deutsch], [Ελληνικά], [English], [Español], [Français], [Italiano], [Magyar], [Melayu], [Nederlands], [Norsk], [Polski], [Português], [Română], [Suomi], [Svenska], [Türkçe], [Русский], [Українська], [العربية], [فارسی], [ភាសាខ្មែរ], [简体中文], [繁體中文], [한국어], [日本語]	●	●	●	28
[Time Zone/DST]	[] (home time zone) or [] (travel time zone): [New York], list of world time zones [*] (DST adjustment): Toggle on or off	●	●	●	28
[Date/Time]	[Date/Time]: – [Date Format]: [Y.M.D], [M.D.Y], [D.M.Y] (Y- year, M- month, D- day) [24H]: Toggle on (24-hour clock) or off (12-hour clock)	●	●	●	27
[ View Assistance]	[ON On], [OFF Off]	●	●	–	95
[LCD Brightness]	*  *	●	●	●	–
[LCD Backlight]	[H Bright], [M Normal], [L Dim]	●	●	●	–
[LCD Mirror Image]	[ON On], [OFF Off]	●	–	–	–
[Viewfinder Backlight]	[H Bright], [M Normal]	●	●	●	–
[Headphone Volume]	, OFF 0-15 (8)	●	●	●	82
[Speaker Volume]	, OFF 0-15 (8)	–	●	●	95
[Notification Sounds]	[] High Volume], [] Low Volume], [OFF Off]	●	●	●	–
[Audio Output CH]	[CH1/2 CH1/CH2], [CH1/1 CH1/CH1], [CH2/2 CH2/CH2], [AII/AII] AII/AII]	●	●	●	105
[Monitor Delay]	[LINE Line Out], [NORM Normal]	●	–	–	82
[Tally Lamp]	[ON On], [OFF Off]	●	●	●	–
[CUSTOM Dial & Button]	[ Tv/Av], [ Manual Exposure], [AGC AGC Limit], [ Exposure], [OFF Off]	●	–	–	90

Menu item	Setting options	CAMERA	MEDIA		📖
			📷	📁	
[Assign Button 1] to [Assign Button 5]*	[🔋] Powered IS], [🔋] BLC Always On], [👤] Face Only AF], [📷] Video Snapshot], [WB] WB Priority], [🔊] Pre REC], [🔊] IR Light], [CH/CH] Audio Output CH], [AF/MF] AF/MF], [REVIEW] Rec Review], [FUNC] Rec. Programs], [FUNC] BLC Always On], [FUNC] White Balance], [FUNC] AGC Limit], [FUNC] Focus], [FUNC] Exposure], [FUNC] Audio Scene], [FUNC] Mic Level], [FUNC] Zoom], [FUNC] Image Stabilizer], [FUNC] Image Effects], [OFF] Off]	●	–	–	91
[Powered IS Button]	[ON] Press and Hold], [ON/OFF] Toggle On/Off]	●	–	–	–
[Set WB Priority]	[AWB] Automatic], [☀️] Daylight], [☁️] Shade], [☁️] Cloudy], [💡] Fluorescent], [💡] Fluorescent H], [💡] Tungsten], [K] Color Temperature], [1] Set 1], [2] Set 2]	●	–	–	–
[Focus Ring Direction]	[NORM] Normal], [REV] Reverse]	●	–	–	–
[Focus Ring Response]	[➡️] Fast], [➡️] Normal], [➡️] Slow]	●	–	–	–
[Focus Preset Speed]	[➡️] Fast], [➡️] Normal], [➡️] Slow]	●	–	–	–
[Battery Info]	–	●	●	●	–
[X415] [Output Terminal]	[OFF] Off], [SDI] HD/SD-SDI], [SDI&HDMI] HD/SD-SDI & HDMI], [HDMI] HDMI], [AV] AV OUT]	●	●	●	103
[Rec Command]	[ON] On], [OFF] Off]	●	–	–	38
[X415] [HD/SD-SDI Output]	[480i] 480i], [720P] 720P], [1080i] 1080i]	●	●	●	103
[HDMI Output]	[A] Automatic], [480i] 480i], [480P] 480P], [720P] 720P], [1080i] 1080i], [1080P] 1080P]	●	●	●	103
[HDMI Time Code]	[ON] On], [OFF] Off]	●	–	–	–
[HDMI Status]	–	●	●	●	–
[Output Onscreen Displays]	[ON] On], [OFF] Off]	●	●	●	–
[Distance Units]	[m] meters], [ft] feet]	●	●	●	–
[Backup Menu Settings B]	[Save], [Load]	●	–	–	93
[GPS Auto Time Setting]**	[Disable], [Auto Update]	●	–	–	–
[GPS Information Display]**	–	●	–	–	–
[Certification Logo Display]	–	●	●	●	–
[Firmware]	–	●	–	–	–

Menu item	Setting options	CAMERA			
		MEDIA			
[Reset All]	[No], [Yes]				

\* The default settings are as follows. [Assign Button 1]: **[AF/MF]** AF/MF, [Assign Button 2]: **[PRE REC]** PRE REC, [Assign Button 3]: **[OFF]** Off, [Assign Button 4]: **[OFF]** Off, [Assign Button 5]: **[REC REVIEW]** Rec Review.

\*\* Option available only when the optional GP-E2 GPS Receiver is attached to the camcorder.

**[LCD Brightness]:** Adjusts the brightness of the LCD screen.

- Changing the brightness of the LCD screen does not affect the brightness of your recordings or the brightness of the playback image on a TV.

**[LCD Backlight]/[Viewfinder Backlight]:** Sets the screen to one of three brightness levels (for the LCD screen) or two brightness levels (for the viewfinder).

- Changing the brightness of the screen does not affect the brightness of your recordings or the brightness of the playback image on a TV.
- Using the **[H Bright]** setting will shorten the effective usage time of the battery pack.

**[LCD Mirror Image]:** When this setting is set to **[ON]** On, this function reverses the image on the screen horizontally when you rotate the LCD panel 180 degrees toward the subject. In other words, the screen will show a mirror image of the subject.

**[Notification Sounds]:** A beep will accompany some of the camcorder's operations.

- While pre-recording ( 85) is activated, the camcorder will not emit any notification sounds.

**[Tally Lamp]:** Activates the tally lamp when the camcorder is recording, the battery level is low or a memory card is full. When set to **[OFF]** Off, the tally lamp will not turn on in these cases. The tally lamp is located on the handle unit so make sure you attach it to the camcorder in advance.

**[Powered IS Button]:** Determines the operation mode of the assignable button set to **[Powered IS]** ( 56).

**[ON] Press and Hold:** Powered IS will be activated while you hold the button pressed down.

**[ON] Toggle On/Off:** Each press of the button will turn the Powered IS function on and off.

**[Set WB Priority]:** Convenient for times when you need to use a particular white balance setting frequently. You can press an assignable button set to **[WB WB Priority]** to switch between the current white balance and the white balance setting selected for **[Set WB Priority]**.

**[Focus Ring Direction]:** Changes the direction the focus/zoom ring needs to be turned. This setting affects the focus/zoom ring only when using it to adjust the focus (when the focus/zoom ring switch is set to FOCUS).

**[Focus Ring Response]:** Selects the sensitivity of the response when operating the focus/zoom ring. This setting affects the focus/zoom ring only when using it to adjust the focus (when the focus/zoom ring switch is set to FOCUS).

**[Focus Preset Speed]:** Determines the speed at which the focus changes to the preset position.

**[Battery Info]:** When you are using a battery pack that is compatible with Intelligent System, this option displays a screen where you can verify the battery charge (as a percentage) and the remaining recording time (**[CAMERA]** mode) or playback time (**[MEDIA]** mode).

- If the battery pack is exhausted, the battery information may not be displayed.

**[HDMI Time Code]:** When set to [**ON** On], the HDMI signal output from the camcorder includes the camcorder's time code.

**[HDMI Status]:** Displays a screen where you can verify the standard of the output signal from the HDMI OUT terminal.

**[Output Onscreen Displays]:** When set to [**ON** On], the camcorder's onscreen displays will appear also on the screen of a TV or monitor connected to the camcorder.

**[Distance Units]:** Selects the units to use for the focusing distance display while focusing manually. This setting also affects units for GPS information when using the optional GP-E2 GPS Receiver.

**[GPS Auto Time Setting]:** When the optional GP-E2 GPS Receiver is attached to the camcorder, you can have the camcorder automatically set the [Date/Time] setting based on the information acquired from GPS. For more details, refer to *Setting Time from GPS on the Camera* in the receiver's instruction manual.

**[GPS Information Display]:** When the optional GP-E2 GPS Receiver is attached to the camcorder, this function allows you to view GPS information. For more details, refer to *Viewing GPS Information* in the receiver's instruction manual.

**[Certification Logo Display]:** This displays select certification logos that apply to this camcorder.

- This setting may not be available depending on the country/region of purchase.

**[Firmware]:** You can verify the current version of the camcorder's firmware. This menu option is usually unavailable.

**[Reset All]:** Resets all of the camcorder's settings.

## Appendix: Onscreen Icons and Displays

### Recording

Onscreen markers (☐119)

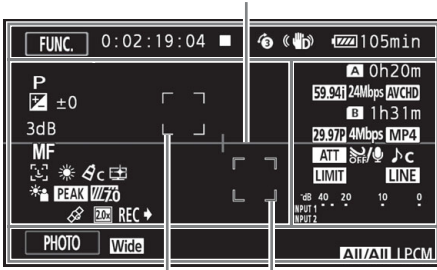

CINEMA mode

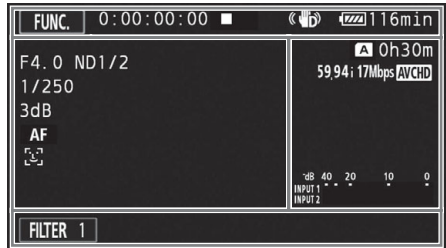

Face detection frame (☐50) Tracking (☐50)

### Left side of the screen

Icon/Display	Description
<b>AUTO</b>	Smart AUTO (☐ 36)
<b>P</b> , <b>Tv</b> , <b>Av</b> , <b>M</b> ,	Recording program (☐ 58, 60, 65)
<b>IR</b> 	Infrared mode (☐ 87) Infrared light
F00.0	Aperture value (☐ 58)
ND1/0	ND filter (☐ 120)
	Exposure compensation (☐ 61)
1/0000	Shutter speed (☐ 58)
00dB	AGC limit (☐ 57)/Gain (☐ 61)
<b>LAF</b> , <b>MAF</b> , <b>AF</b> , <b>MF</b>	Focus (☐ 47)
	Face detection & tracking (☐ 50)
<b>AWB</b> ,	White balance (☐ 63)
<b>A c</b> 	Image effects (☐ 67) [Highlight Priority] look
	Backlight correction (☐ 62)
<b>PEAK</b> , <b>PEAK</b>	Peaking (☐ 48)
<b>70</b> , <b>100</b>	Zebra pattern (☐ 61)
	GPS active (☐ 88) Only when the optional GP-E2 GPS Receiver is attached to the camcorder.
<b>20x</b>	Digital tele-converter (☐ 55)
<b>REC</b> →, <b>STBY</b> →	Recording command (☐ 38)

## Top of the screen

Icon/Display	Description
[FUNC.]	Opens the FUNC. menu ( 29).
[PHOTO]	Takes a photo ( 35).
0:00:00.00, 0:00:00:00	Time code ( 69)
■, ●	Recording operation ( 35) ■ Record standby, ● Recording
2sec, 4sec, 8sec	Video snapshot length ( 84)
Ⓢ	Pre-recording mode ( 85)
Ⓢ, Ⓢ, ⓈP	Image stabilizer ( 56)
▢, ▢, ▢, ▢, (in red)	Remaining battery charge ( 130)

## Right side of the screen

Icon/Display	Description
[A] / [B] 0h00m	Remaining recording time
[A] / [B] END (in red)	No more free space on the memory card.
[A] / [B] 0h00m	Relay recording ( 41)
59.94P, 59.94I, P/F29.97, 29.97P, 23.98P	Frame rate ( 42)
00Mbps	Recording mode ( 40)
AVCHD, MP4	Movie format ( 34)
12 / 24 x0000.00	Slow & fast motion recording mode ( 43)
ATT, ATT OFF	Microphone attenuator ( 80)
Low, OFF	Wind screen ( 79)
Ⓢ, Ⓢ, Ⓢ, Ⓢ, Ⓢc	Audio scenes ( 76)
LIMIT	Audio peak limiter ( 75)
LINE	MIC terminal input ( 80)
-8 40 20 10 0 INPUT 1 INPUT 2	Audio recording level ( 74, 77)
START, STOP	Start/stop recording ( 35, 37) Appears on the zooming screen.



## Bottom of the screen

Icon/Display	Description
[PHOTO]	Takes a photo (📷 35).
[FILTER 1]	Cinema-look filters (🎬 45)
<b>Tele</b> , <b>Wide</b>	Conversion lens (📷 119)
<b>CH1</b> , <b>CH2</b> , <b>AV/AI</b>	Audio output channel (📷 105)
LPCM	Linear PCM audio (📷 40)

129

## Playback

## Movies

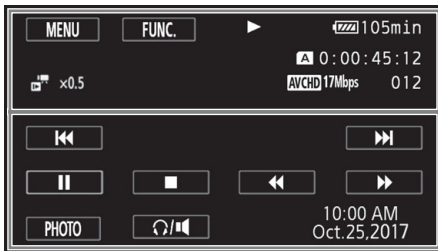

## Photos

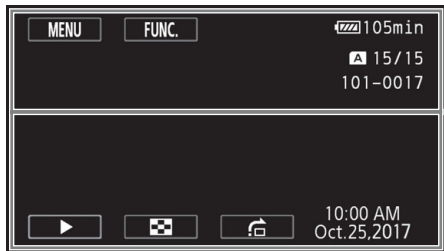

## Top of the screen

Icon/Display	Description
[MENU]	Opens the setup menus (📖 118).
[FUNC.]	Opens the FUNC. menu (📖 29).
▶,	Playback operation ▶: Playback,   : Playback pause
LPCM	Linear PCM audio (📷 40)
[A] / [B]	Memory card in use.
0:00:00.00, 0:00:00:00	Time code (📖 69)
000/000	Current photo / Total number of photos
📷 / 📷 x0000.00	Slow & fast motion recording mode (📖 43)
📷	[Highlight Priority] look (📖 67)
<b>AVCHD</b> , <b>MP4</b>	Movie format (📖 34)
00Mbps	Recording mode (📖 40)
000	Scene number
000-0000	File number (📖 122)

Bottom of the screen

Icon/Display	Description
	Playback controls for movies (📖 95)
[PHOTO]	Captures a photo from a movie (📖 97).
	Headphone/Speaker volume (📖 95)
	Playback controls for photos (📖 107)
Time and date F00.0 1/0000	Data code (📖 86)

NOTES

- You can press the DISP. button to turn off most icons and displays.

**Remaining battery time**

- The icon shows a rough estimate of the remaining charge as a percentage of the full charge of the battery pack. The remaining recording/playback time of the battery pack is displayed, in minutes, next to the icon.
- When the battery charge becomes low, will appear in yellow. When the battery pack is exhausted, will appear in red. Replace or charge the battery pack.
- When you attach an empty battery pack, the power may turn off without displaying .
- Depending on the conditions under which the camcorder and the battery pack are used, the actual battery charge may not be indicated accurately.
- When the camcorder is off, press the BATT. INFO button to display the charge status of a battery pack. The Intelligent System will display the charge status (as a percentage) and the remaining recording time (in minutes) for 5 seconds. If the battery pack is exhausted, the battery information may not be displayed.

## Troubleshooting

If you have a problem with your camcorder, refer to this section. Sometimes what you think is a malfunction of the camcorder may have the simplest of solutions - please read the "CHECK THIS FIRST" box before going on to the more detailed problems and solutions. Consult your dealer or a Canon Service Center if the problem persists.

### CHECK THIS FIRST

#### Power supply

- Is the battery charged? Is the compact power adapter correctly connected to the camcorder? (□ 16)

#### Recording

- Did you turn the camcorder on and correctly set it to **CAMERA** mode? (□ 35) Is a memory card correctly inserted into the camcorder? (□ 32)

#### Playback

- Did you turn the camcorder on and correctly set it to **MEDIA** mode? (□ 94, 107) Is a memory card correctly inserted into the camcorder? (□ 32) Does it contain any recordings?

#### Other

- Does the camcorder make a rattling sound? The internal lens fixture can move when the camcorder is turned off or in **MEDIA** mode. This is not a malfunction.

### Power source

#### The camcorder will not turn on or it turns off by itself.

- The battery pack is exhausted. Replace or charge the battery pack.
- Remove the battery pack and reattach it correctly.

#### Cannot charge the battery pack.

- Make sure the camcorder is off so charging can start.
- The temperature of the battery pack is outside its operating range (approximately 0 – 40 °C (32 – 104 °F)). Remove the battery pack, warm it or let it cool down, as necessary, and try charging it again.
- Charge the battery pack in temperatures between approximately 0 °C and 40 °C (32 °F and 104 °F).
- The battery pack is faulty. Replace the battery pack.
- The camcorder cannot communicate with the battery pack attached. Battery packs not recommended by Canon for use with this camcorder cannot be charged using this camcorder.
- If you are using a battery pack recommended by Canon for use with this camcorder, there may be a problem with the camcorder or battery pack. Consult a Canon Service Center.

#### A noise can be heard from the compact power adapter.

- A faint sound can be heard while the compact power adapter is connected to a power outlet. This is not a malfunction.

#### The battery pack is exhausted extremely quickly even at normal temperatures.

- The battery may have reached the end of its battery life. Buy a new battery pack.

## Recording

### Pressing the START/STOP button will not start recording.

- You cannot record while the camcorder is writing previous recordings onto a memory card (while the ACCESS indicator is on or flashing). Wait until the camcorder has finished.
- The memory card is full or it already contains 3,999 scenes (the maximum number of scenes for AVCHD movies). Delete some recordings (□ 98, 109) or initialize the memory card (□ 32) to free some space.
- The file numbers have reached their maximum value. Insert a new memory card in to the camcorder and set [FUNC.] ➤ [MENU] ➤ [ ] ➤ [File Numbering] to [Reset].

### The point where the START/STOP button was pressed does not match the beginning/end of the recording.

- There may be a slight interval between pressing the START/STOP button and the actual start/end of recording. This is not a malfunction.

### The camcorder will not focus.

- Autofocus does not work on the subject. Focus manually (□ 47).
- The lens or Instant AF sensor is dirty. Clean the lens or sensor with a soft lens-cleaning cloth (□ 144). Never use tissue paper to clean the lens.

### When a subject flits across in front of the lens, the image appears slightly bent.

- This is a phenomenon typical of CMOS image sensors. When a subject crosses very quickly in front of the camcorder, the image may seem slightly warped. This is not a malfunction.

### Changing the operating mode between recording (●)/record standby (■)/playback (▶) takes longer than usual.

- When the memory card contains a large number of scenes, some operations may take longer than usual. Save your recordings (□ 110) and initialize the memory card (□ 32).

### Movies or photos cannot be recorded properly.

- This may occur as movies and photos are recorded/deleted over time. Save your recordings (□ 110) and initialize the memory card (□ 32).

### Cannot record a photo while recording movies.

- You cannot take photos in **CINEMA** mode.

### After using the camcorder for a long time, it becomes hot.

- The camcorder may become hot after using it continuously for long periods of time; this is not a malfunction. If the camcorder becomes unusually hot or it becomes hot after using it only for a short while, it may indicate a problem with the camcorder. Consult a Canon Service Center.

## Playback

### Cannot delete a scene.

- You may not be able to delete scenes recorded or edited using another device.

### Deleting scenes takes longer than usual.

- When the memory card contains a large number of scenes, some operations may take longer than usual. Save your recordings (□ 110) and initialize the memory card (□ 32).

### Cannot divide scenes

- You cannot divide scenes recorded or edited using another device and then transferred to a memory card connected to the computer.
- The memory card is full. Delete some recordings (□ 98, 109) to free some space.

### Cannot copy scenes/photos

- You may not be able to copy scenes/photos recorded or edited using another device and then transferred to a memory card connected to the computer.

### Cannot mark individual scenes/photos in the index screen with a checkmark ✓

- You cannot select more than 100 scenes/photos individually. Select the [All Scenes] or [All Photos] option instead of [Select].

## Indicators and Onscreen Displays

### lights up in red.

- Battery pack is exhausted. Replace or charge the battery pack.

### appears on the screen.

- The camcorder cannot communicate with the battery pack attached so the remaining battery time cannot be displayed.

### The tally lamp does not light up.

- Change the [FUNC.] ➤ [MENU] ➤  ➤ [Tally Lamp] setting to [On].

### The tally lamp flashes quickly (4 flashes per second).

- The battery pack is exhausted. Replace or charge the battery pack.
- The memory card is full. Delete some recordings ( 98, 109) to free some space or replace the memory card.

### / lights up in red.

- The memory card is full. Delete some recordings ( 98, 109) to free some space or replace the memory card.

### / lights up in red.

- A memory card error occurred. Turn off the camcorder. Remove and reinsert the memory card. Initialize the memory card if the display does not change back to normal.

### Even after stopping recording, the ACCESS indicator does not go off.

- The scene is being recorded on the memory card. This is not a malfunction.

### The red POWER/CHG indicator flashes rapidly (one flash at 0.5-second intervals).

- The temperature of the battery pack is outside its operating range (approximately 0 – 40 °C (32 – 104 °F)). Remove the battery pack, warm it or let it cool down, as necessary, and try charging it again.
- Charge the battery pack in temperatures between approximately 0 °C and 40 °C (32 °F and 104 °F).
- The battery pack is damaged. Use a different battery pack.
- Charging has stopped because the compact power adapter or the battery pack is faulty. Consult a Canon Service Center.

## Picture and Sound

### The screen appears too dark.

- Adjust the brightness with the [FUNC.] ➤ [MENU] ➤  ➤ [LCD Brightness] or [LCD Backlight] setting.

### Screen displays turn on and off repeatedly.

- The battery pack is exhausted. Replace or charge the battery pack.
- Remove the battery pack and reattach it correctly.

**Abnormal characters appear on the screen and the camcorder does not operate properly.**

- Disconnect the power source and reconnect it after a short time.

**Video noise appears on screen.**

- Keep a distance between the camcorder and devices that emit strong electromagnetic fields (plasma TVs, cellular phones, etc.).

**Horizontal bands appear on the screen.**

- This is a phenomenon typical of CMOS image sensors when recording under certain lighting conditions. This is not a malfunction. You may be able to reduce the symptoms by setting [FUNC.] ➤ [MENU] ➤  ➤ [Flicker Reduction] to [Automatic]. Alternatively, set the shutter speed to a value matching the frequency of the local electrical system (1/100 for 50 Hz systems, 1/60 for 60 Hz systems).



**Viewfinder picture is blurred.**

- Adjust the viewfinder with the dioptic adjustment lever ( 20).

**No picture appears on the viewfinder.**

- Close the LCD panel and then pull out the viewfinder to activate it.

**Audio cannot be recorded.**

- When using a microphone connected to the MIC terminal, make sure the microphone is turned on. Also, make sure its battery is not exhausted.
- The INPUT terminal ON/OFF switch is not set correctly ( 76) or the audio recording level is not set correctly ( 77).
- An external microphone that requires phantom power is connected to an INPUT terminal. Set the input selection switch for that terminal to MIC+48V ( 73).

**Sound is distorted or is recorded at lower levels.**

- When recording near loud sounds (such as fireworks, shows or concerts), sound may become distorted or it may not be recorded at the actual levels. Adjust the audio recording level manually ( 77).

**The picture is displayed correctly but there is no sound from the built-in speaker.**





- Speaker volume is turned off. Adjust the volume ( 95).
- If the STV-250N Stereo Video Cable is connected to the camcorder, disconnect it.

## Memory Card and Accessories

**Cannot insert the memory card.**

- The memory card was not facing the correct direction. Turn the memory card over and insert it.

**Cannot record on the memory card.**

- The memory card is full. Delete some recordings ( 98, 109) to free some space or replace the memory card.
- Initialize the memory card ( 32) when you use it with the camcorder for the first time.
- The LOCK switch on the memory card is set to prevent accidental erasure. Change the position of the LOCK switch.
- A compatible memory card must be used to be able to record movies on a memory card ( 31).
- The folder and file numbers have reached their maximum value. Set [FUNC.] ➤ [MENU] ➤  ➤ [File Numbering] to [Reset] and insert a new memory card.

## Connections with External Devices

### Video noise appears on the TV screen.

- When using the camcorder in a room where a TV is located, keep a distance between the compact power adapter and the power or antenna cables of the TV.

### Playback looks fine on the camcorder but there is no image on the TV screen.

- The video input on the TV is not set to the video terminal to which you connected the camcorder. Select the correct video input.

### The camcorder is connected using the optional HTC-100 High Speed HDMI Cable, but there is no picture or sound from the HDTV.

- Disconnect the High Speed HDMI cable and then restore the connection or turn the camcorder off and then on again.
- When [FUNC.] ➤ [MENU] ➤  ➤ [HDMI Output] is set to an option other than [Automatic], the external monitor is not compatible with the signal output from the camcorder. Set [HDMI Output] to [Automatic] or an option compatible with the monitor.

### The computer does not recognize the camcorder even though the camcorder is connected correctly.

- Disconnect the USB cable and turn off the camcorder. After a short while, turn it on again and restore the connection.
- Connect the camcorder to a different USB port on the computer.

### Cannot save photos on my computer

- When the memory card contains too many photos (Windows – 2,500 or more, macOS – 1,000 or more), you may not be able to transfer photos to a computer. Try using a card reader to transfer the photos on the memory card.

## List of Messages (in alphabetical order)

### Accessing the memory card. Do not remove the memory card.

- You opened the double memory card slot cover while the camcorder was accessing the memory card or the camcorder started accessing the memory card as you opened the double memory card slot cover. Do not remove the memory card until this message disappears.

### Back up recordings regularly

- This message may appear when you turn on the camcorder. In the event of a malfunction, recordings may be lost so back up your recordings regularly.

### Battery pack is not compatible. Turning off the camcorder.

- A battery pack not recommended by Canon for use with this camcorder was attached and the camcorder was turned on. The camcorder will automatically turn off in 4 seconds.

### Cannot communicate with the battery pack. Continue using this battery pack?

- You attached a battery pack that is not recommended by Canon for use with this camcorder.
- If you are using a battery pack recommended by Canon for use with this camcorder, there may be a problem with the camcorder or battery pack. Consult a Canon Service Center.

### Cannot convert scenes recorded at 59.94P

- Scenes that were recorded with a recording mode of 28 Mbps LPCM (59.94P), 28 Mbps (59.94P) or 35 Mbps (59.94P) cannot be converted.

**Cannot convert the scene**

- The camcorder cannot convert scenes that were recorded using a video configuration that is not supported (PAL or SECAM).
- You cannot convert scenes that were recorded or edited using another device and then transferred to a memory card connected to a computer.
- MP4 scenes recorded with a recording mode of 4 Mbps can only be converted to MP4 movies with a recording mode of 4 Mbps or 3 Mbps. Similarly, MP4 scenes recorded with a recording mode of 3 Mbps can only be converted to MP4 movies with a recording mode of 3 Mbps.

**Cannot divide the scene.**

**Cannot divide the scene. Initialize only using the camcorder.**

- The scene could not be divided because the camcorder's internal scene management data log is full. Save your recordings (□ 110) and initialize the memory card (□ 32). Try dividing the scene again.
- Use the software Data Import Utility to save the scene and divide it on the computer.

**Cannot join 23.98P and 29.97P scenes to convert them**

**Cannot join 59.94i and 23.98P scenes to convert them**

**Cannot join PF29.97 and 23.98P scenes to convert them**

- The combination of scenes you are trying to convert does not allow for joining scenes due to the scenes' frame rate settings. Convert the scenes to MP4 without joining them.

**Cannot play back Check the memory card**

- There is a problem with the memory card. Save your recordings (□ 110) and initialize the memory card using the [Complete Initialization] option (□ 32). If the problem persists, use a different memory card.

**Cannot play back Initialize only using the camcorder**

- The memory card in the camcorder was initialized using a computer. Initialize the memory card with this camcorder (□ 32).

**Cannot play back**

- Movies cannot be played back from a 64 MB or smaller memory card. Use a recommended memory card (□ 31).

**Cannot record Check the memory card**

- There is a problem with the memory card. Save your recordings (□ 110) and initialize the memory card using the [Complete Initialization] option (□ 32). If the problem persists, use a different memory card.

**Cannot record movies on this memory card**

- Movies cannot be recorded on a 64 MB or smaller memory card. Use a recommended memory card (□ 31).

**Cannot record**

- There is a problem with the memory card. If this message appears often without apparent reason, contact a Canon Service Center.

**Cannot trim the scene**

- MP4 movies that were copied to a memory card with a larger cluster size than the memory card they were recorded on cannot be trimmed.
- MP4 movies that were recorded or copied using other devices cannot be trimmed.

**Charge the battery pack**

- Battery pack is exhausted. Charge the battery pack.



### Check the memory card

- Cannot access the memory card. Check the memory card and make sure it is inserted correctly.
- A memory card error occurred. The camcorder cannot record or display the image. Try removing and reinserting the memory card, or use a different memory card.
- You inserted a MultiMedia Card (MMC) into the camcorder. Use a recommended memory card (□ 31).
- If after the message disappears, [A]/[B] appears in red, perform the following: Turn off the camcorder and remove and reinsert the memory card. If [A]/[B] turns back to green you can resume recording/playback. If the problem persists, save your recordings (□ 110) and initialize the memory card (□ 32).

### Do not disconnect the power source. Do not disconnect the USB cable unless you first use the computer to safely end the connection.

- When the camcorder is in [MEDIA] mode and is connected to the computer with a USB cable, the camcorder cannot be operated. Disconnecting the USB cable or power source while this message appears may result in permanent loss of the recordings on the memory card. Use the computer's Safely Remove Hardware function to end the connection and disconnect the USB cable before using the camcorder.

### File name error

- The folder and file numbers have reached their maximum value. Set [FUNC.] ➤ [MENU] ➤ [ ] ➤ [File Numbering] to [Reset] and delete all the MP4 movies (□ 98) and photos (□ 109) on the memory card or initialize it (□ 32).

### Initialize only using the camcorder

- Initialize the memory card with this camcorder (□ 32).

### May not be possible to record movies on this memory card

- You may not be able to record movies on a memory card without a Speed Class rating or rated SD Speed Class 2. Replace the memory card with one rated SD Speed Class 4, 6 or 10.

### Mem. Card Number of scenes already at maximum

- The memory card already contains 3,999 scenes (the maximum number of scenes for AVCHD movies); no further scenes can be copied onto the memory card. Delete some scenes (□ 98) to free some space.

### Mem. Card Unable to recognize the data

- The memory card contains scenes recorded using a video configuration that is not supported (PAL or SECAM). Play back the recordings in the memory card with the device originally used to record them.

### Memory card A/B writing error Attempt to recover the data? (Can take up to 3 min.)

- This message will appear the next time you turn on the camcorder if power supply was accidentally interrupted while the camcorder was writing to the memory card. Select [Recover] to try to recover the recordings. If you inserted a memory card that contains scenes recorded using another device, we recommend that you select [No].

### Memory card cover is open

- After inserting a memory card, close the double memory card slot cover.

### Memory card is full

- The memory card is full. Delete some recordings (□ 98, 109) to free some space or replace the memory card.

### Memory card is write-protected

- The LOCK switch on the memory card is set to prevent accidental erasure. Change the position of the LOCK switch.

**Need to recover files from the memory card. Change the position of the LOCK switch on the memory card.**

- This message will appear the next time you turn on the camcorder if power supply was accidentally interrupted while the camcorder was writing on the memory card and later the position of the card's LOCK switch was changed to prevent erasure. Change the position of the LOCK switch.

**No memory card**

- Insert a compatible memory card into the camcorder (☐ 32).

**No photos**

- There are no photos to play back.

**No scenes**

- There are no scenes on the memory card selected.

**Not enough available space**

- Delete some recordings to free some space (☐ 98, 109).
- Set the recording mode to 5 Mbps for AVCHD movies or 3 Mbps for MP4 movies.
- The available space on the memory card is less than the size of the recordings you are trying to copy. Delete some recordings to free some space (☐ 98, 109) or reduce the number of recordings to copy.

**Number of scenes already at maximum**

- The number of scenes on the memory card has reached 3,999 (the maximum number of scenes for AVCHD movies). Delete some scenes (☐ 98) to free some space.

**Recording was stopped due to insufficient write speed of the memory card**

- The write speed of the memory card was too slow so recording was stopped. Replace the memory card with one rated SD Speed Class 4, 6 or 10.
- When the recording mode is 28 Mbps LPCM, 28 Mbps or 35 Mbps, you must use a memory card rated SD Speed Class 6 or 10.
- When recording movies using slow & fast motion, you must use a memory card rated SD Speed Class 10.
- After repeatedly recording, deleting and editing scenes (fragmented memory), it will take longer to write data on the memory card and recording may stop. Save your recordings (☐ 110) and initialize the memory card (☐ 32).

**Scene recorded using another device. Cannot copy the scene.**

**Scene recorded using another device. Cannot divide the scene.**

- Scenes that were not recorded with this camcorder cannot be copied or divided with this camcorder.

**Some scenes could not be deleted**

- Movies that were protected/edited with other devices and then transferred to a memory card connected to the computer cannot be deleted with this camcorder.

**Some scenes were recorded using another device and cannot be copied.**

- Scenes that were not recorded with this camcorder cannot be copied.

**Task in progress. Do not disconnect the power source.**

- The camcorder is updating the memory card. Wait until the operation ends and do not disconnect the compact power adapter or remove the battery pack.

**This photo cannot be displayed**

- You may not be able to display photos taken with other devices or image files created or edited on a computer and then transferred to a memory card connected to the computer.

**To record video on this memory card, it is recommended to use a video quality setting other than [59.94P Recording].**

- When using a memory card rated SD Speed Class 2 or 4, you may not be able to record movies if you use a recording mode of 28 Mbps LPCM (59.94P), 28 Mbps (59.94P) or 35 Mbps (59.94P).

**To use this function change the camera mode to Manual or Cinema**

- The CUSTOM button, the CUSTOM dial (☐ 90) and some of the functions that can be assigned to the assignable buttons (☐ 91) cannot be used in **AUTO** mode. Set the mode switch to **M** (☐ M mode) or **CINEMA** (☐ CINEMA mode) to use them.

139

**Too many photos. Disconnect the USB cable.**

- Disconnect the USB cable. Try using a memory card reader or decrease the number of photos on the memory card to fewer than 2,500 (Windows), or 1,000 (macOS).
- If a dialog box appeared on the computer screen, close it. Disconnect the USB cable, and restore the connection after a short while.

**Unable to recognize the data**

- The camcorder cannot recognize data that was recorded using a video configuration that is not supported (PAL or SECAM).

**Unable to recover data**

- Could not recover a corrupted file. Save your recordings (☐ 110) and initialize the memory card using the [Complete Initialization] option (☐ 32).

## Safety Instructions and Handling Precautions

Be sure to read these instructions in order to operate the product safely.

### **WARNING**

**Denotes the risk of serious injury or death.**

- Stop using the product in any case of unusual circumstances such as the presence of smoke or a strange smell.
- Do not touch any exposed internal parts.
- Do not get the product wet. Do not insert foreign objects or liquids into the product.
- Do not touch the product connected to a power outlet during lightning storms. This may cause electric shock.
- Do not disassemble or modify the product.
- Do not expose the product to strong shocks or vibration.
- Observe the following instructions when using commercially available batteries or provided battery packs.
  - Use batteries/battery packs only with their specified product.
  - Do not heat batteries or expose them to fire.
  - Do not charge batteries/battery packs using non-authorized battery chargers.
  - Do not expose the terminals to dirt or let them come into contact with metallic pins or other metal objects.
  - Do not use leaking batteries/battery packs. If a battery/battery pack leaks and the material contacts your skin or clothing, flush the exposed area thoroughly with running water. In case of eye contact, flush thoroughly with copious amounts of clean running water and seek immediate medical assistance.
  - When disposing of batteries/battery packs, insulate the terminals with tape or other means. This may cause electric shock, explosion or fire.
- Use only power sources specified in this instruction manual for use with the product.
- Observe the following instructions when using a battery charger or AC adapter.
  - Do not plug in or unplug the product with wet hands.
  - Do not use the product if the power plug is not fully inserted into the power outlet.
  - Do not expose the power plug and terminals to dirt or let them come into contact with metallic pins or other metal objects.
  - Do not place heavy objects on the power cord. Do not damage, break or modify the power cord.
  - Do not wrap the product in cloth or other materials when in use or shortly after use when the product is still warm in temperature.
  - Do not unplug the product by pulling the power cord.
  - Do not leave the product connected to a power source for long periods of time.
- Do not allow the product to maintain contact with the same area of skin for extended periods of time during use. This may result in low-temperature contact burns, including skin redness and blistering, even if the product does not feel hot. The use of a tripod or similar equipment is recommended when using the product in hot places and for people with circulation problems or less sensitive skin.
- Keep the product out of the reach of young children.
- Periodically remove any dust buildup from the power plug and power outlet using a dry cloth.
- Follow any indications to turn off the product in places where its use is forbidden. Not doing so may cause other equipment to malfunction due to the effect of electromagnetic waves and even result in accidents.

**⚠ CAUTION****Denotes the risk of injury.**

- Do not leave the product in places exposed to extremely high or low temperatures. The product may become extremely hot/cold and cause burns or injury when touched.
- Only mount the product on a tripod that is sufficiently sturdy.
- Do not look at the screen or through the viewfinder for prolonged periods of time. This may induce symptoms similar to motion sickness. In such a case, stop using the product immediately and rest for a while before resuming use.

**Camcorder**

Be sure to observe the following precautions to ensure maximum performance.

- **Save your recordings periodically.** Make sure to transfer your recordings to an external device such as a computer or digital video recorder (□ 110) and save them on a regular basis. This will protect your important recordings in case of damage and create more free space on the memory card. Canon shall not be liable for any data loss.
- Do not use or store the camcorder in dusty or sandy places. The camcorder is not waterproof – avoid also water, mud or salt. If any of the above should get into the camcorder it may damage the camcorder and/or the lens.
- Do not use the camcorder near strong electromagnetic fields such as near powerful magnets and motors, MRI machines or high-voltage power lines. Using the camcorder in such places may cause anomalies in the video, or audio or video noise to appear.
- Do not point the lens or viewfinder at strong light sources. Do not leave the camcorder pointed at a bright subject. Take special care when the camcorder is mounted on a tripod or the camcorder is being carried as the lens or viewfinder might be pointed toward such strong light sources. When the camcorder is not in use, make sure the lens barrier is closed.
- Do not carry the camcorder by the LCD panel. Be careful when closing the LCD panel. When using a wrist strap, do not allow the camcorder to swing and hit an object.
- **Handle the touch screen with care.** Do not apply excessive force and do not use ballpoint pens or other hard-tipped tools to operate the touch screen. This may damage the touch screen's surface.
- Do not attach protective film on the touch screen. The camcorder features a capacitive touch screen so you may not be able to correctly operate the touch screen with an additional protective layer.
- When mounting the camcorder on a tripod, make sure that the tripod's fastening screw is shorter than 6.5 mm (0.26 in.). Using other tripods may damage the camcorder.
- **When recording movies, try to get a calm, stable picture.** Excessive camcorder movement while shooting and extensive use of fast zooms and panning can result in jittery scenes. In extreme cases, the playback of such scenes may result in visually induced motion sickness. If you experience such a reaction, stop the playback immediately and take a rest break as necessary.

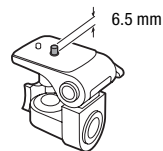
**Long-term storage**

If you do not intend to use the camcorder for a long time, store it in a place free of dust, in low humidity, and at temperatures not higher than 30 °C (86 °F).

## Battery Pack

### DANGER!

#### Treat the battery pack with care.

- Keep it away from fire (or it might explode).
- Do not expose the battery pack to temperature higher than 60 °C (140 °F). Do not leave it near a heater or inside a car in hot weather.
- Do not try to disassemble or modify it.
- Do not drop it or subject it to shocks.
- Do not get it wet.
  
- Dirty terminals may cause a poor contact between the battery pack and the camcorder. Wipe the terminals with a soft cloth.



### Long-term storage

- Store battery packs in a dry place at temperatures no higher than 30 °C (86 °F).
- To extend the battery life of the battery pack, discharge it completely before storing it.
- Charge and discharge all your battery packs fully at least once a year.

### Remaining battery time

When you are using a battery pack that is compatible with Intelligent System, if the remaining battery time displayed is not correct, charge the battery pack fully. Still, the correct time may not be displayed after a large number of repeated uses, if a fully charged battery pack is left unused, or if a battery pack is used for long periods of time in high temperatures. Use the time shown on the screen as an approximation.

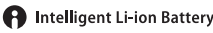
### Regarding the use of non-Canon battery packs

- For your safety, battery packs that are not genuine Canon battery packs will not be charged even if you attach them to this camcorder or to the optional CG-800 Battery Charger.
- We recommend using genuine Canon battery packs bearing the Intelligent System mark. 
- If you attach to the camcorder battery packs that are not genuine Canon battery packs,  will appear and the remaining battery time will not be displayed.

### Memory Card

- We recommend backing up the recordings on the memory card onto your computer. Data may be corrupted or lost due to memory card defects or exposure to static electricity. Canon shall not be liable for lost or corrupted data.
- Do not touch or expose the terminals to dust or dirt.
- Do not use memory cards in places subject to strong magnetic fields.
- Do not leave memory cards in places subject to high humidity and high temperature.
- Do not disassemble, bend, drop, or subject memory cards to shocks and do not expose them to water.
- Check the direction before inserting the memory card. Forcing a memory card into a slot if it is not correctly oriented may damage the memory card or the camcorder.
- Do not attach any labels or stickers on the memory card.

- Secure Digital (SD) memory cards have a physical switch to prevent writing on the card so as to avoid the accidental erasure of the card's content. To write-protect the memory card set the switch to the LOCK position.

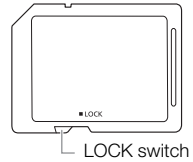

## Built-in Rechargeable Lithium Battery

The camcorder has a built-in rechargeable lithium battery to keep the date/time and other settings. The built-in lithium battery is recharged while you use the camcorder; however, it will discharge completely if you do not use the camcorder for about 3 months.

**To recharge the built-in lithium battery:** Connect the compact power adapter to the camcorder and leave it connected for 24 hours with the camcorder off.

## Disposal

When you delete movies or initialize a memory card, only the file allocation table is altered and stored data is not physically erased. When you dispose of a memory card or give either to another person, initialize it using the [Complete Initialization] option (□ 32). Fill it up with unimportant recordings, and then initialize it again using the same option. This makes recovering the original recordings very difficult.

## Maintenance/Others

### Cleaning

#### Camcorder Body

- Use a soft, dry cloth to clean the camcorder body. Never use chemically treated cloths or volatile solvents such as paint thinner.

#### Lens, Viewfinder and Instant AF Sensor

- If the lens surface or Instant AF sensor is dirty, autofocus may not work properly.
- Remove any dust or dirt particles using a non-aerosol type blower.
- Use a clean, soft lens-cleaning cloth to gently wipe the lens or viewfinder. Never use tissue paper.

#### LCD Touch Screen

- Clean the LCD touch screen using a clean, soft lens-cleaning cloth.
- Condensation may form on the surface of the screen when the temperature changes suddenly. Wipe it with a soft dry cloth.

### Condensation

Moving the camcorder rapidly between hot and cold temperatures may cause condensation (water droplets) to form on its internal surfaces. Stop using the camcorder if condensation is detected. Continued use may damage the camcorder.

#### Condensation may form in the following cases:

- When the camcorder is moved quickly from cold to warm places
- When the camcorder is left in a humid room
- When a cold room is heated rapidly

#### To avoid condensation

- Do not expose the camcorder to sudden or extreme changes in temperature.
- Remove the memory card and battery pack. Then, place the camcorder in an airtight plastic bag and let it adjust gradually to temperature changes before removing it from the bag.

#### When condensation is detected

The precise time required for water droplets to evaporate will vary depending on the location and weather conditions. As a general rule, wait for 2 hours before resuming use of the camcorder.

### Viewing the Certification Logo

You can open the [FUNC.] ➤ [MENU] ➤  ➤ [Certification Logo Display] screen to view some certification information for this camcorder.



---

## Using the Camcorder Abroad

### Power Sources

You can use the compact power adapter to operate the camcorder and to charge battery packs in any country with power supply between 100 and 240 V AC, 50/60 Hz. Consult a Canon Service Center for information on plug adapters for overseas use.

### Playback on a TV Screen

You can only play back your recordings on TVs compatible with the NTSC system. NTSC is used in the following regions/countries:

**Americas:** All of North America and Central America; most Caribbean islands (except in French territories like Guadeloupe and Martinique); most of South America (except in Argentina, Brazil and Uruguay). **Asia:** Only in Japan, the Philippines, South Korea, Taiwan and Myanmar. **Oceania:** US territories (Guam, American Samoa, etc.) and some Pacific islands like Micronesia, Samoa and Tonga.

## Optional Accessories (Availability differs from area to area)

The following optional accessories are compatible with this camcorder. Select accessories are described in more detail in the following pages.



BP-820, BP-828  
Battery Pack



CG-800  
Battery Charger



CA-570 Compact  
Power Adapter



TL-H58  
Tele-converter



WA-H58 Wide  
Attachment

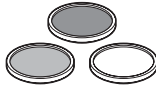

Protect Filter 58 mm,  
ND4L Filter 58 mm,  
ND8L Filter 58 mm

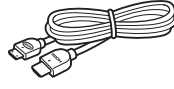

HTC-100 High Speed  
HDMI Cable

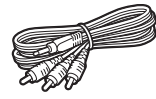

STV-250N  
Stereo Video Cable

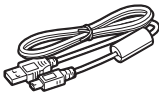

IFC-400PCU  
USB Cable



GP-E2  
GPS Receiver

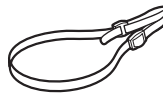

SS-600/SS-650  
Shoulder Strap



WS-20  
Wrist Strap



SC-2000  
Soft Carrying Case

Call or visit your local retailer/dealer for genuine Canon video accessories. You can also obtain genuine accessories for your Canon camcorder by calling: 1-800-828-4040, Canon U.S.A. Information Center.

**Use of genuine Canon accessories is recommended.**

This product is designed to achieve excellent performance when used with genuine Canon accessories. Canon shall not be liable for any damage to this product and/or accidents such as fire, etc., caused by the malfunction of non-genuine Canon accessories (e.g., a leakage and/or explosion of a battery pack). Please note that this warranty does not apply to repairs arising out of the malfunction of non-genuine Canon accessories, although you may request such repairs on a chargeable basis.

### Battery Packs

When you need extra battery packs, select one of the following models: BP-820 or BP-828.

When you use battery packs bearing the Intelligent System mark, the camcorder will communicate with the battery and display the remaining usage time (accurate to 1 minute). You can only use and charge these battery packs with camcorders and chargers compatible with Intelligent System.

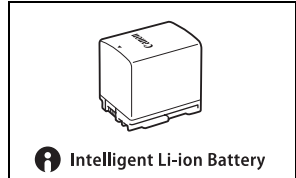

### CG-800 Battery Charger

Use the battery charger to charge the battery packs. It plugs directly into a power outlet without a cable.

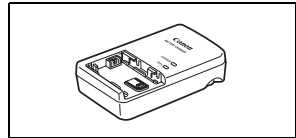

### TL-H58 Tele-converter

This Tele-converter lens increases the focal length of the camcorder lens by a factor of 1.5.

- The Tele-converter cannot be used together with the supplied lens hood with lens barrier.
- The image stabilizer is not as effective when the Tele-converter is attached.
- The minimum focusing distance at full telephoto with the Tele-converter is 1.3 m (4.3 ft.).

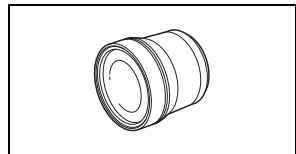

### WA-H58 Wide Attachment

This Wide Attachment lens decreases the focal length by a factor of 0.75, giving you a wide perspective for indoor shots or panoramic views.

- The Wide Attachment cannot be used together with the supplied lens hood with lens barrier.

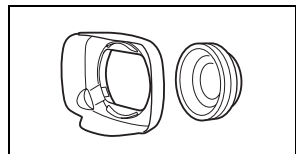

### Protect Filter 58 mm, ND4L Filter 58 mm, ND8L Filter 58 mm

Neutral density and MC protector filters help you to control difficult lighting conditions.

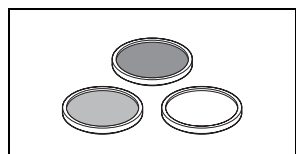

### SC-2000 Soft Carrying Case

A handy camcorder bag with padded compartments and plenty of space for accessories.



This mark identifies genuine Canon video accessories. When you use Canon video equipment, we recommend Canon-brand accessories or products bearing the same mark.



# Specifications

## XA15 / XA11

◆ – Values given are approximate figures.

### System

- **Recording System**

Movies: AVCHD<sup>1</sup> Video: MPEG-4 AVC/H.264;  
 Audio: Linear PCM, 16 bits, 48 kHz, 2ch<sup>2</sup>  
 Dolby Digital 2ch  
 MP4 Video: MPEG-4 AVC/H.264  
 Audio: MPEG-2 AAC-LC (2ch)

Photos: DCF (Design rule for Camera File system), compatible with Exif<sup>3</sup> Ver. 2.3  
 Image type: JPEG

<sup>1</sup> Compatible with AVCHD ver. 2.0 specifications.

<sup>2</sup> Linear PCM is available only when the recording mode is 28 Mbps LPCM or 24 Mbps LPCM.

<sup>3</sup> This camcorder supports Exif 2.3 (also called "Exif Print"). Exif Print is a standard for enhancing the communication between camcorders and printers. By connecting to an Exif Print-compliant printer, the camcorder's image data at the time of shooting is used and optimized, yielding extremely high quality prints.

- **Recording Media**

SD, SDHC (SD High Capacity) or SDXC (SD eXtended Capacity) memory card (not included);  
 two memory card slots

- **Image Sensor**

1/2.84-inch CMOS, 3,090,000 pixels◆  
 Effective pixels: 2,910,000 pixels◆

- **LCD Touch Screen:** 3.0 in., wide, TFT color, 460,000 dots◆, 100% coverage, capacitive touch screen operation

- **Viewfinder:** 0.24 in., wide, color, equivalent to 1,560,000 dots◆, 100% coverage

- **Microphone:** Stereo electret condenser microphone, attenuator (20 dB)

- **Lens**

f=3.67-73.4 mm, F/1.8-2.8, 20x optical zoom, 8-bladed circular aperture  
 35 mm equivalent: 26.8 – 576 mm◆  
 28.8 – 576 mm◆ (when Dynamic IS is activated)

- **Lens Configuration:** 12 elements in 10 groups (double-sided aspheric element)

- **AF System**

Autofocus (TTL + external distance sensor when set to [Instant AF] or [Medium AF]) or Manual focus

- **Filter Diameter:** 58 mm

- **Minimum Focusing Distance**

60 cm (2 ft.); 1 cm (0.39 in.) at full wide angle

- **White Balance**

Auto white balance, Custom white balance (2 settings), User-defined color temperature or Preset white balance settings: Daylight, Shade, Cloudy, Fluorescent, Fluorescent H, Tungsten

- **Minimum Illumination**  
0.1 lx ([Low Light] recording program, Shutter speed at 1/2)  
1.2 lx ([Programmed AE] recording program, Auto slow shutter [On], Shutter speed at 1/30)
- **Recommended Illumination:** More than 100 lx
- **Image Stabilization:** Optical-Shift Image Stabilizer
- **Size of Video Recordings**  
AVCHD movies:  
28 Mbps (59.94P), 28 Mbps (59.94P), 24 Mbps (59.94P), 24 Mbps (59.94P), 17 Mbps (59.94P): 1920 x 1080 pixels; 5 Mbps (59.94P): 1440 x 1080 pixels  
MP4 movies:  
35 Mbps (59.94P), 24 Mbps (59.94P), 17 Mbps (59.94P): 1920 x 1080 pixels; 8 Mbps (59.94P), 4 Mbps (59.94P): 1280 x 720 pixels; 3 Mbps (59.94P): 640 x 360 pixels
- **Size of Photos:** 1920 x 1080 pixels  
1280 x 720 pixels (when recording MP4 movies at 8 or 4 Mbps)  
640 x 360 pixels (when recording MP4 movies at 3 Mbps)  
1920 x 1080 pixels (photos captured from movies)

## Terminals

- **✕15 HD/SD-SDI Terminal**  
BNC jack, output only, 0.8 Vp-p / 75 Ω, unbalanced  
HD-SDI: SMPTE 292M  
Video: 1080i, 720P  
SD-SDI: SMPTE 259M  
Video: 480i  
Embedded audio, time code (VITC/LTC)
- **HDMI OUT Terminal:** HDMI mini connector; output only
- **USB Terminal:** mini-B receptacle, Hi-Speed USB; output only
- **AV OUT Terminal**  
Ø 3.5 mm 4-pole minijack; output only  
Video: 1 Vp-p / 75 Ω unbalanced  
Audio: -10 dBV (47 kΩ load) / 3 kΩ or less
- **MIC Terminal**  
Ø 3.5 mm stereo minijack (unbalanced)  
Sensitivity:  
For microphone input: -65 dBV (auto volume, full scale -12 dB) / 5 kΩ or more  
For line input: -30 dBV (auto volume, full scale -12 dB) / 5 kΩ or more  
Microphone attenuator: 20 dB
- **INPUT Terminal**  
INPUT jack (pin1: shield, pin2: hot, pin3: cold), 2 sets (balanced)  
Sensitivity:  
For microphone input: -60 dBu (manual volume center, full scale -18 dB) / 600 Ω  
For line input: 4 dBu (manual volume center, full scale -18 dB) / 10 kΩ  
Microphone attenuator: 20 dB
- **Ⓜ (headphone) Terminal**  
Ø 3.5 mm stereo minijack (unbalanced)  
-29 dBV (16 Ω load, Max volume) / 100 Ω

- **REMOTE Terminal:** Ø 2.5 mm stereo sub-mini jack; input only

### Power/Others

- **Power supply (rated)**  
7.4 V DC (battery pack), 8.4 V DC (compact power adapter)
- **Power consumption<sup>◆</sup>:**  
**XA15** 4.8 W **XA11** 4.7 W (17 Mbps, AF on, LCD normal brightness)
- **Operating temperature<sup>◆</sup>:** 0 – 40 °C (32 – 104 °F)
- **Dimensions<sup>◆</sup> [W x H x D] (excluding the grip belt)**  
Camcorder only: 109 x 84 x 182 mm (4.3 x 3.3 x 7.2 in.)  
Camcorder with the lens hood attached: 115 x 84 x 231 mm (4.5 x 3.3 x 9.1 in.)  
Camcorder with the lens hood and handle unit attached: 131 x 180 x 231 mm (5.2 x 7.1 x 9.1 in.)
- **Weight<sup>◆</sup>**  
**XA15**  
Camcorder only: 750 g (1.7 lb.)  
Camcorder with lens hood, BP-820 Battery Pack, memory card, handle unit: 1140 g (2.5 lb.)  
**XA11**  
Camcorder only: 745 g (1.6 lb.)  
Camcorder with lens hood, BP-820 Battery Pack, memory card, handle unit: 1135 g (2.5 lb.)

### CA-570 Compact Power Adapter

- **Power supply:** 100 – 240 V AC, 50/60 Hz
- **Rated output / consumption:** 8.4 V DC, 1.5 A / 29 VA (100 V) – 39 VA (240 V)
- **Operating temperature<sup>◆</sup>:** 0 – 40 °C (32 – 104 °F)
- **Dimensions<sup>◆</sup>:** 52 x 29 x 90 mm (2.1 x 1.1 x 3.5 in.)
- **Weight<sup>◆</sup>:** 135 g (4.8 oz.)

### BP-820 Battery Pack

- **Battery type**  
Rechargeable lithium ion battery, compatible with Intelligent System
- **Rated voltage:** 7.4 V DC
- **Operating temperature<sup>◆</sup>:** 0 – 40 °C (32 – 104 °F)
- **Battery capacity:** 1780 mAh (typical); 13 Wh / 1700 mAh (minimum)
- **Dimensions<sup>◆</sup>:** 30.7 x 39.4 x 40.2 mm (1.2 x 1.6 x 1.6 in.)
- **Weight<sup>◆</sup>:** 85 g (3.0 oz.)

## Reference Tables

### Approximate recording times

The camcorder uses a variable bit rate (VBR) to encode video so the actual recording times will vary depending on the subject.

152

For AVCHD movies:

Recording mode → Memory card ↓	28 Mbps LPCM (59.94P) and 28 Mbps (59.94P)	24 Mbps LPCM and 24 Mbps	17 Mbps	5 Mbps
8 GB Memory card	35 min.	40 min.	1 hr.	3 hr.
16 GB Memory card	1 hr. 15 min.	1 hr. 25 min.	2 hr. 5 min.	6 hr. 5 min.
32 GB Memory card	2 hr. 30 min.	2 hr. 55 min.	4 hr. 10 min.	12 hr. 15 min.*
64 GB Memory card	5 hr. 5 min.	5 hr. 55 min.	8 hr. 20 min.	24 hr. 30 min.*
128 GB Memory card	10 hr. 10 min.	11 hr. 55 min.	16 hr. 45 min.*	49 hr.*

For MP4 movies:

Recording mode → Memory card ↓	35 Mbps (59.94P)	24 Mbps	17 Mbps	8 Mbps (59.94P)	4 Mbps	3 Mbps
8 GB Memory card	30 min.	40 min.	1 hr.	2 hr. 10 min.	4 hr. 20 min.	5 hr. 40 min.
16 GB Memory card	1 hr.	1 hr. 25 min.	2 hr. 5 min.	4 hr. 20 min.	8 hr. 40 min.	11 hr. 25 min.
32 GB Memory card	2 hr.	2 hr. 55 min.	4 hr. 10 min.	8 hr. 40 min.	17 hr. 20 min.*	22 hr. 55 min.*
64 GB Memory card	4 hr.	5 hr. 55 min.	8 hr. 20 min.	17 hr. 20 min.*	34 hr. 45 min.*	45 hr. 55 min.*
128 GB Memory card	8 hr.	11 hr. 55 min.	16 hr. 45 min.*	34 hr. 45 min.*	69 hr. 30 min.*	91 hr. 55 min.*

\* A single scene can be recorded continuously for 12 hours; at that point, the camcorder will stop.

### Approximate number of photos

The photo size and number of photos that can be saved on a 1 GB memory card are summarized in the following table. However, the actual number of photos that can be recorded will vary depending on the subject and shooting conditions.

Movie Format	Recording mode	Photo size	Number of photos
AVCHD	Any	1920x1080	660
MP4	35 Mbps, 24 Mbps, 17 Mbps	1920x1080	660
	8 Mbps, 4 Mbps	1280x720	1,490
	3 Mbps	640x360	5,800



## Charging, Recording and Playback Times

The charging times given in the following table are approximate and vary according to charging conditions and initial charge of the battery pack.

Battery pack→	BP-820	BP-828
Charging conditions↓		
Using the camcorder	275 min.	405 min.
Using the CG-800 Battery Charger*	190 min.	260 min.

\* When using the CG-800 Battery Charger, an ambient temperature between 10 °C and 30 °C (50 °F and 86 °F) is recommended. For safety reasons, charging outside of the recommended temperature range may result in considerably longer charging times. Charging will not start if either the battery or ambient temperature is outside of an approximate 5 °C to 35 °C (41 °F to 95 °F) range.

Recording and playback times given in the following tables are approximate and vary according to recording mode and charging, recording or playback conditions. The times are based on using the LCD screen. The effective usage time of the battery pack may decrease when recording in cold surroundings, when using the brighter screen settings, etc.

### **XA15** Recording AVCHD movies

Battery pack	Recording mode	Recording (maximum)	Recording (typical)*	Playback
BP-820	28 Mbps LPCM (59.94P) / 28 Mbps (59.94P)	140 min.	85 min.	230 min.
	17 Mbps	150 min.	95 min.	240 min.
	5 Mbps	155 min.	90 min.	250 min.
BP-828	28 Mbps LPCM (59.94P) / 28 Mbps (59.94P)	210 min.	135 min.	345 min.
	17 Mbps	225 min.	145 min.	360 min.
	5 Mbps	230 min.	145 min.	370 min.

### **XA15** Recording MP4 movies

Battery pack	Recording mode	Recording (maximum)	Recording (typical)*	Playback
BP-820	35 Mbps (59.94P)	140 min.	85 min.	230 min.
	17 Mbps	165 min.	100 min.	245 min.
	3 Mbps	170 min.	100 min.	260 min.
BP-828	35 Mbps (59.94P)	210 min.	130 min.	345 min.
	17 Mbps	245 min.	155 min.	370 min.
	3 Mbps	260 min.	165 min.	390 min.

**XA171** Recording AVCHD movies

Battery pack	Recording mode	Recording (maximum)	Recording (typical)*	Playback
BP-820	28 Mbps LPCM (59.94P) / 28 Mbps (59.94P)	145 min.	90 min.	240 min.
	17 Mbps	155 min.	95 min.	250 min.
	5 Mbps	155 min.	95 min.	255 min.
BP-828	28 Mbps LPCM (59.94P) / 28 Mbps (59.94P)	215 min.	135 min.	355 min.
	17 Mbps	230 min.	145 min.	375 min.
	5 Mbps	235 min.	145 min.	385 min.

**XA171** Recording MP4 movies

Battery pack	Recording mode	Recording (maximum)	Recording (typical)*	Playback
BP-820	35 Mbps (59.94P)	145 min.	90 min.	235 min.
	17 Mbps	165 min.	105 min.	255 min.
	3 Mbps	175 min.	105 min.	270 min.
BP-828	35 Mbps (59.94P)	215 min.	130 min.	355 min.
	17 Mbps	250 min.	160 min.	380 min.
	3 Mbps	270 min.	165 min.	405 min.

\* Approximate times for recording with repeated operations such as start/stop, zooming, and power on/off.

# Index

## A

Abroad, using the camcorder	145
AGC (automatic gain control) limit	57
Aperture (f number)	58, 60
Aspect ratio of a connected TV (TV type)	121
Assignable buttons	91
Audio equalizer	79
Audio output	105
Audio recording level	77
Audio reference signal	83
Audio scene select	76
AUTO mode	35
Auto slow shutter	120
Autofocus	49
Av (recording program)	58
AV OUT terminal	102, 104
AVCHD format	40

## B

Backlight correction	62
Battery pack	
Battery information	125
Charging	16
Remaining charge indicator	130
Beach (recording program)	65
Built-in backup battery	143
Built-in microphone	72

## C

Capturing photos from a movie	97
Charging time	153
CINEMA mode	45
Cinema-look filters	45
Color bars	83
Compact power adapter	16
Condensation	144
Connection to an external monitor	102
Converting movies to MP4 format	114
Copying recordings to a memory card	112
CUSTOM button	90
CUSTOM dial	90

## D

Data code	86, 121
Data Import Utility	110
Date and time	27
DC IN terminal	16

## Deleting

Movies	98
Photos	109
Digital tele-converter	55
Dioptic adjustment	20
Dividing scenes	100
Dual recording	41

## E

Error messages	135
Exposure compensation	61
External microphone	73

## F

Face detection	50
Ferrite core, attaching	16
Fireworks (recording program)	66
Flicker reduction	120
Focus	47
Focus preset	48
Focus/zoom ring	47, 52
Frame rate	42
FUNC. menu	29, 117

## H

Handle unit	19
HD/SD-SDI terminal*	103
HDMI OUT terminal	102, 103
Headphones	82
⌚ (headphones) terminal	82
High-speed zoom	54
Highlight AE	62
Highlight Priority	67

## I

Image effects	67
Image stabilizer	56
Infrared light	87
Infrared recording	87
Initializing a memory card	32
INPUT terminal	72
Intelligent IS	37

## L

Language	28
LCD touch screen	25
Lens hood	20
Looks	67
Low cut filter	80

\* XA15 only.

Low light (recording program) .....65

**M**

M (Manual) mode .....37  
Maintenance .....144  
Manual exposure .....60  
Manual focus .....47  
Markers .....120  
Memory card .....31, 142  
Menu settings, saving and loading .....93  
MIC terminal .....73  
Microphone attenuator .....75, 80  
Microphone directionality .....78  
Mode switch .....25  
Monitor delay .....105  
Movie format (AVCHD/MP4) .....33  
MP4 format .....40

**N**

ND filter .....120  
Night scene (recording program) .....65  
Notification sounds .....125

**O**

Onscreen display selection .....86  
Onscreen icons .....127

**P**

P (recording program) .....58  
Peaking .....48  
Playback  
    Movies .....94  
    Photos .....107  
Portrait (recording program) .....65  
Powered IS .....56  
Pre-recording .....85

**R**

Recording  
    Movies .....35, 37, 45  
    Photos .....35, 37  
Recording audio .....72  
Recording mode .....40  
Recording programs .....58, 60, 65  
Recording time .....152  
Relay recording .....41  
Resetting all camcorder settings .....126  
Reviewing recordings .....39

**S**

Saving recordings  
    Using a computer .....110  
    Using external video recorders .....115  
Selecting the memory card  
    for recording .....33  
Serial number .....13  
Setup menus .....30, 118  
Shutter speed .....58, 60  
Slow & fast motion .....43  
Smart AUTO .....36  
Snow (recording program) .....65  
Speaker .....95  
Special Scene recording programs .....65  
Sports (recording program) .....65  
Spotlight (recording program) .....66  
Sunset (recording program) .....65

**T**

Tally lamp .....125  
Telephoto .....52  
Time code .....69  
Time zone/DST .....28  
Touch AE .....61  
Touch AF .....47  
Touch screen operations .....25  
Trimming scenes .....101  
Tripod .....141  
Troubleshooting .....131  
Turning off notification sounds .....125  
Turning the camcorder on/off .....24  
Tv (recording program) .....58

**U**

USB terminal .....102, 115  
User bit .....71

**V**

Video snapshot .....84  
View assistance .....95  
Viewfinder .....20  
Volume .....95

**W**

White balance .....63  
Wide angle .....52  
Wide DR .....67  
Wind screen .....79

## **Z**

Zebra pattern .....	61
Zoom .....	52
Digital zoom .....	119
Soft zoom control .....	55
Zoom speed .....	53

## CANON PROFESSIONAL DIGITAL VIDEO EQUIPMENT LIMITED WARRANTY FOR PRODUCTS PURCHASED IN THE UNITED STATES

The limited warranty set forth below is given by Canon U.S.A., Inc. ("Canon USA") with respect to Canon Professional Digital Video Equipment (the "Equipment") packaged with this limited warranty and purchased in the United States. This limited warranty is only effective upon presentation of your Bill of Sale or other proof of purchase. The Equipment is warranted to the original end-user purchaser, when delivered in new condition in its original container, under normal use against defective materials or workmanship as follows:

Parts: Defective parts will be exchanged for new parts or comparable rebuilt parts for a period of ONE YEAR from the date of original purchase.

Labor: For a period of ONE YEAR from the date of original purchase, labor will be provided free of charge by Canon USA's factory service centers or designated service facilities located in the United States.

When returning Equipment under this warranty, you must pre-pay the shipping charges, and you must enclose a copy of the Bill of Sale or other proof of purchase with a complete explanation of the problem. During the ONE-YEAR warranty period, repairs will be made and the Equipment will be return-shipped to you free of charge. For repairs after the warranty period is over, you will be given an estimate of the cost of repair and an opportunity to approve or disapprove of the repair expense before it is incurred. If you approve, repairs will be made and the Equipment will be returned to you at your risk and expense. If you disapprove, we will return-ship the Equipment to you at no charge to you to an address within the United States.

**This limited warranty only applies if the Equipment is used in conjunction with compatible computer equipment and compatible software, as to which items Canon USA will have no responsibility. Canon USA shall have no responsibility under this limited warranty for use of the Equipment in conjunction with incompatible peripheral equipment and/or incompatible software. Non-Canon brand peripheral equipment and software which may be distributed with, or factory loaded on, the Equipment, are sold 'AS IS' without warranty of any kind by Canon USA, including any implied warranty regarding merchantability or fitness for a particular purpose. The sole warranty with respect to such non-Canon brand items is given by the manufacturer or producer thereof. If the Equipment contains a hard disk drive, Canon USA recommends that data stored on that drive be duplicated or backed up to prevent its loss in the event of failure or other malfunction of such drive.**

In order to obtain warranty service, please contact the authorized Canon retail dealer from whom you purchased the Equipment or contact the CANON INFORMATION CENTER AT **855-CINE-EOS** (855-246-3367) or on the Internet at [pro.usa.canon.com/support](http://pro.usa.canon.com/support). You will be directed to the nearest service facility for your Equipment.

This Limited Warranty covers all defects encountered in normal use of the Equipment and does not apply in the following cases:

- A. Loss or damage to the Equipment due to abuse, mishandling, accident, improper maintenance, use of non-Canon accessories or failure to follow operating, maintenance or environmental instructions prescribed in Canon USA's user's manual;
- B. If the Equipment is defective as a result of leaking batteries, sand, dirt or water damage;
- C. If defects or damages are caused by the use of parts or supplies (other than those sold by Canon USA) that cause damage to the Equipment or that cause abnormally frequent service calls or service problems;
- D. If defects or damages are caused by service other than Canon USA's factory service centers or authorized service facilities;
- E. Any internal modification to product hardware or firmware;
- F. Any applicable fee for Maintenance of the Equipment;
- G. If the Equipment has had its serial number or dating altered or removed.

This Limited Warranty does not apply to Equipment purchased outside the United States. This Limited Warranty does not apply to accessories or consumables for the Equipment, which are sold "AS IS", without warranty of any kind by Canon USA. Please retain this warranty card and your Bill of Sale as a permanent record of your purchase. This card ensures that you are contacted promptly should there be a safety inspection, modification or product recall under applicable laws or regulations.

**NO IMPLIED WARRANTY, INCLUDING MERCHANTABILITY AND FITNESS FOR A PARTICULAR PURPOSE APPLIES TO THIS EQUIPMENT AFTER THE APPLICABLE PERIOD OF EXPRESS WARRANTY OR GUARANTEE (EXCEPT AS MENTIONED ABOVE) GIVEN BY ANY PERSON, FIRM OR CORPORATION WITH RESPECT TO THIS EQUIPMENT SHALL BIND THE UNDERSIGNED (SOME STATES DO NOT ALLOW LIMITATIONS ON HOW LONG AN IMPLIED WARRANTY LASTS, SO THE ABOVE LIMITATION OR EXCLUSION MAY NOT APPLY TO YOU). CANON USA SHALL NOT BE LIABLE FOR LOSS OF REVENUES OR PROFITS, EXPENSE FOR SUBSTITUTE EQUIPMENT OR SERVICE, STORAGE CHARGES, LOSS OR CORRUPTION OF DATA, INCLUDING WITHOUT LIMITATION, LOSS OR CORRUPTION OF DATA STORED ON THE EQUIPMENT'S HARD DRIVE, OR ANY OTHER SPECIAL, INCIDENTAL OR CONSEQUENTIAL DAMAGES CAUSED BY THE USE, MISUSE OR INABILITY TO USE THE EQUIPMENT, REGARDLESS OF THE LEGAL THEORY ON WHICH THE CLAIM IS BASED, AND EVEN IF CANON USA HAS BEEN ADVISED OF THE POSSIBILITY OF SUCH DAMAGES. NOR SHALL RECOVERY OF ANY KIND AGAINST CANON USA BE GREATER THAN THE PURCHASE PRICE OF THE EQUIPMENT SOLD BY CANON USA AND CAUSING THE ALLEGED DAMAGE. WITHOUT LIMITING THE FOREGOING, YOU ASSUME ALL RISK AND LIABILITY FOR LOSS, DAMAGE OR INJURY TO YOU AND YOUR PROPERTY AND TO OTHERS AND THEIR PROPERTY ARISING OUT OF USE, MISUSE OR INABILITY TO USE THE EQUIPMENT NOT CAUSED DIRECTLY BY THE NEGLIGENCE OF CANON USA (SOME STATES DO NOT ALLOW THE EXCLUSION OR LIMITATION OF INCIDENTAL OR CONSEQUENTIAL DAMAGES, SO THE ABOVE LIMITATION MAY NOT APPLY TO YOU). THIS WARRANTY SHALL NOT EXTEND TO ANYONE OTHER THAN THE ORIGINAL PURCHASER OF THIS EQUIPMENT OR THE PERSON FOR WHOM IT WAS PURCHASED AS A GIFT.**

This warranty gives you specific legal rights, and you may also have other rights which vary from state to state.

CANON U.S.A., INC.

## CANON PROFESSIONAL DIGITAL VIDEO EQUIPMENT LIMITED WARRANTY FOR PRODUCTS PURCHASED IN CANADA

The limited warranty set forth below is given by Canon Canada Inc. ("Canon Canada") with respect to Canon Professional Digital Video Equipment (the "Equipment") packaged with this limited warranty and purchased in Canada. This limited warranty is only effective upon presentation of your Bill of Sale or other proof of purchase. The Equipment is warranted to the original end-user purchaser, when delivered in new condition in its original container, under normal use against defective materials or workmanship as follows:

Parts: Defective parts will be exchanged for new parts or comparable rebuilt parts for a period of ONE YEAR from the date of original purchase.

Labor: For a period of ONE YEAR from the date of original purchase, labor will be provided free of charge by Canon Canada's factory service center or designated service facilities located in Canada.

When returning Equipment under this warranty, you must pre-pay the shipping charges, and you must enclose a copy of the Bill of Sale or other proof of purchase with a complete explanation of the problem. During the ONE-YEAR warranty period, repairs will be made and the Equipment will be return-shipped to you free of charge. For repairs after the warranty period is over, you will be given an estimate of the cost of repair and an opportunity to approve or disapprove of the repair expense before it is incurred. If you approve, repairs will be made and the Equipment will be returned to you at your risk and expense. If you disapprove, we will return-ship the Equipment to you at no charge to you to an address within Canada.

**This limited warranty only applies if the Equipment is used in conjunction with compatible computer equipment and compatible software, as to which items Canon Canada will have no responsibility. Canon Canada shall have no responsibility under this limited warranty for use of the Equipment in conjunction with incompatible peripheral equipment and/or incompatible software. Non-Canon brand peripheral equipment and software which may be distributed with, or factory loaded on, the Equipment, are sold 'AS IS' without warranty of any kind by Canon Canada, including any implied warranty or condition regarding merchantability or fitness for a particular purpose. The sole warranty with respect to such non-Canon brand items is given by the manufacturer or producer thereof. If the Equipment contains a hard disk drive, Canon Canada recommends that data stored on that drive be duplicated or backed up to prevent its loss in the event of failure or other malfunction of such drive.**

In order to obtain warranty service, please contact the authorized Canon retail dealer from whom you purchased the Equipment or contact the CANON PROFESSIONAL SERVICE CENTRE 1-800-667-2666 or on the Internet at [www.canon.ca/pro](http://www.canon.ca/pro). You will be directed to the nearest service facility for your Equipment.

This Limited Warranty covers all defects encountered in normal use of the Equipment and does not apply in the following cases:

- A. Loss or damage to the Equipment due to abuse, mishandling, accident, improper maintenance, use of non-Canon accessories or failure to follow operating, maintenance or environmental instructions prescribed in Canon Canada's user's manual;
- B. If the Equipment is defective as a result of leaking batteries, sand, dirt or water damage;
- C. If defects or damages are caused by the use of parts or supplies (other than those sold by Canon Canada) that cause damage to the Equipment or that cause abnormally frequent service calls or service problems;
- D. If defects or damages are caused by service other than Canon Canada's factory service centers or authorized service facilities;
- E. Any internal modification to product hardware or firmware;
- F. Any applicable fee for Maintenance of the Equipment;
- G. If the Equipment has had its serial number or dating altered or removed.

This Limited Warranty does not apply to Equipment purchased outside Canada. This Limited Warranty does not apply to accessories or consumables for the Equipment, which are sold "AS IS", without warranty of any kind by Canon Canada. Please retain this warranty card and your Bill of Sale as a permanent record of your purchase. This card ensures that you are contacted promptly should there be a safety inspection, modification or product recall under applicable laws or regulations.

**NO IMPLIED WARRANTY OR CONDITION, INCLUDING MERCHANTABILITY AND FITNESS FOR A PARTICULAR PURPOSE APPLIES TO THIS EQUIPMENT AFTER THE APPLICABLE PERIOD OF EXPRESS WARRANTY OR GUARANTY (EXCEPT AS MENTIONED ABOVE) GIVEN BY ANY PERSON, FIRM OR CORPORATION WITH RESPECT TO THIS EQUIPMENT SHALL BIND THE UNDERSIGNED (SOME PROVINCES DO NOT ALLOW LIMITATIONS ON HOW LONG AN IMPLIED WARRANTY OR CONDITION LASTS, SO THE ABOVE LIMITATION OR EXCLUSION MAY NOT APPLY TO YOU). CANON CANADA SHALL NOT BE LIABLE FOR LOSS OF REVENUES OR PROFITS, EXPENSE FOR SUBSTITUTE EQUIPMENT OR SERVICE, STORAGE CHARGES, LOSS OR CORRUPTION OF DATA, INCLUDING WITHOUT LIMITATION, LOSS OR CORRUPTION OF DATA STORED ON THE EQUIPMENT'S HARD DRIVE, OR ANY OTHER SPECIAL, INCIDENTAL OR CONSEQUENTIAL DAMAGES CAUSED BY THE USE, MISUSE OR INABILITY TO USE THE EQUIPMENT, REGARDLESS OF THE LEGAL THEORY ON WHICH THE CLAIM IS BASED, AND EVEN IF CANON CANADA HAS BEEN ADVISED OF THE POSSIBILITY OF SUCH DAMAGES. NOR SHALL RECOVERY OF ANY KIND AGAINST CANON CANADA BE GREATER THAN THE PURCHASE PRICE OF THE EQUIPMENT SOLD BY CANON CANADA AND CAUSING THE ALLEGED DAMAGE. WITHOUT LIMITING THE FOREGOING, YOU ASSUME ALL RISK AND LIABILITY FOR LOSS, DAMAGE OR INJURY TO YOU AND YOUR PROPERTY AND TO OTHERS AND THEIR PROPERTY ARISING OUT OF USE, MISUSE OR INABILITY TO USE THE EQUIPMENT NOT CAUSED DIRECTLY BY THE NEGLIGENCE OF CANON CANADA (SOME PROVINCES DO NOT ALLOW THE EXCLUSION OR LIMITATION OF INCIDENTAL OR CONSEQUENTIAL DAMAGES, SO THE ABOVE LIMITATION MAY NOT APPLY TO YOU). THIS WARRANTY SHALL NOT EXTEND TO ANYONE OTHER THAN THE ORIGINAL PURCHASER OF THIS EQUIPMENT OR THE PERSON FOR WHOM IT WAS PURCHASED AS A GIFT.**

This warranty gives you specific legal rights, and you may also have other rights which vary from province to province.

CANON CANADA INC.



Canon Inc. 30-2, Shimomaruko 3-chome, Ohta-ku, Tokyo 146-8501, Japan

---

**USA** <http://pro.usa.canon.com>

**CANON U.S.A., INC.**

<http://pro.usa.canon.com/support>

 (855) CINE-EOS (855-246-3367)

(USA only)

---

The information in this document is verified as of May 2020. Subject to change without notice. Visit your local Canon website to download the latest version.